

ENC 2012

EUROPEAN NUCLEAR CONFERENCE



Transactions End of Use



ENS CONFERENCE

ENC 2012 Diamond Sponsor:



ENC 2012 Gold Sponsors:



ENC 2012 Silver Sponsor:



ENC 2012 Sponsor:



organised in collaboration with:



© 2012
European Nuclear Society
Rue Belliard 65
1040 Brussels, Belgium
Phone + 32 2 505 30 54
Fax +32 2 502 39 02
E-mail ens@euronuclear.org
Internet www.euronuclear.org

ISBN 978-92-95064-14-0

These transactions contain all contributions submitted by 7 December 2012.

The content of contributions published in this book reflects solely the opinions of the authors concerned. The European Nuclear Society is not responsible for details published and the accuracy of data presented.

ENC2012-A0010	radiological mapping with an unmanned helicopter	Rottner, B. (1); Tantot, P. (2); Plantier, P. (3) 1 - Onet Technologies, France 2 - Survey Copter , France 3 - Onectra, France
ENC2012-A0011	treatment of evaporator concentrates from PWR	Rottner, B. (1) 1 - ONET Technologies, France
ENC2012-A0128	Strong and weak dependencies when calculating activities of waste-filled drums	Kröhn, M. (1); Sokcic-Kostic, M. (1); Langer, F. (1); Schultheis, R. (1) 1 - NUKEM Technologies GmbH, Germany
ENC2012-A0150	INNOVATIVE APPROACH FOR FIRE RISK ANALYSIS DURING DESIGN STAGE FOR NON REACTOR NUCLEAR FACILITIES	Traichel, A. (1); Mummert, M. (1); Dilger, M. (1) 1 - NUKEM Technologies GmbH, Germany
ENC2012-A0228	Compact incineration systems for thermal treatment of radioactive waste	Slametschka, R. (1); Büttner, K. (1); Schetter, G. (2) 1 - NUKEM Technologies GmbH, Germany 2 - Dipl.-Ing. Ruppmann Verbrennungsanlagen GmbH, Germany
ENC2012-A0024	Technology and Management for the Decommissioning of Nuclear Facilities - A Report from Germany.	Stifi, A. (1); Kern, P. (1); Aminy, A. (1); Gentes, S. (1) 1 - Karlsruhe Institut of Technology (KIT) - Institute for Technology and Management in Construction, Germany
ENC2012-A0030	WESTINGHOUSE WASTE SIMULATION AND OPTIMIZATION SOFTWARE TOOL	Boucau, J. (1); Aign, J. (2); Mennicken, K. (2) 1 - Westinghouse Electric Company, Belgium 2 - Westinghouse Electric Company, Germany
ENC2012-A0048	Safety aspects of Belgonucléaire Dessel MOX Plant decommissioning in Belgium: Experience from a German MOX-facility and recent improvements applied to the Belgian project	Baumann, R. (1); Cuchet, J.-M. (2); Kohlgarth, E. (3); Vandorpe, M. (4); Libon, H. (5); Deboodt, P. (6) 1 - Siemens Energy, Germany 2 - Tractebel Engineering, Belgium 3 - TÜV NORD EnSys Hannover GmbH & Co. KG, Germany 4 - Tecnubel, Belgium 5 - Belgonucleaire, Belgium 6 - SCK.CEN, Belgium
ENC2012-A0095	NPP DECOMMISSIONING AND MANAGEMENT OF RADIOACTIVE WASTE : THE EDF EXPERIENCE	Béguin, S. (1); Desroches, E. (1); Bernet, P. (2) 1 - EDF Nuclear Fuel Division, France 2 - EDF CIDEN, France
ENC2012-A0211	Advances in laser cutting as a decommissioning and dismantling tool	Hilton, P. (1); Khan, A. (1); Buckingham, R. (2) 1 - TWI Ltd, United Kingdom 2 - OC Robotics Ltd, United Kingdom
ENC2012-A0243	CONDITIONAL REUSE - PERSPECTIVE METHOD IN THE DECOMMISSIONING MATERIALS MANAGEMENT PROCESS	Zachar, M. (1); Daniska, V. (1); Necas, V. (2) 1 - DECOM, a.s., Slovakia 2 - Slovak University of Technology in Bratislava, Slovakia
ENC2012-A0013	The Cigéo geological repository project in France	Harman, A. (1); Labalette, T. (1); Dupuis, M.-C. (1); Ouzounian, G. (1) 1 - ANDRA, France

ENC2012-A0097	Nuclear Data issues in the calculation of C14 and C136 in irradiated graphite.	Mills, R. (1); Banford, A. (1); Riaz, Z. (1) 1 - National Nuclear Laboratory, United Kingdom
ENC2012-A0149	Geological Disposal of the UK Radioactive Waste - Underpinning Science and Technology	Smart, N. (1) 1 - Nuclear Decommissioning Authority, United Kingdom
ENC2012-A0153	Management of radioactive waste and dismantling of nuclear facilities, THE FRENCH EXPERIENCE	Ouzounian, G. (1) 1 - French Nuclear Industry, France
ENC2012-A0056	DESTRUCTION OF LIQUID ORGANICS IN RADIOACTIVE WASTES USING ADSORPTION AND ELECTROCHEMICAL REGENERATION	Brown, N. (1); Wickenden, D. (2); Roberts, E. (3); Adams, A. (1) 1 - Arvia Technology Ltd, United Kingdom 2 - Magnox Ltd, United Kingdom 3 - University of Manchester, United Kingdom
ENC2012-A0085	Monitoring and Inspection Techniques for Long Term Storage of Higher Activity Waste Packages	Bolton, G. (1) 1 - National Nuclear Laboratory, United Kingdom
ENC2012-A0123	MANAGEMENT OF OPERATIONAL RADIOACTIVE WASTE FROM TRIGA RESEARCH REACTOR: A PRACTICAL SOLUTION FOR DISPOSAL	Costel danut, B. (1); Liliana, B. (1); Marius, I. (1) 1 - Institute for Nuclear Research, Romania
ENC2012-A0221	CHALLENGES OF WASTE MANAGEMENT FROM LEU BASED Mo99 PRODUCTION	Wisnubroto, D. S. (1) 1 - National Nuclear Energy Agency of Indonesia, Indonesia
ENC2012-A0302	SLOVAK BENTONITES AS NATURAL BARRIERS IN RADIOACTIVE WASTE MANAGEMENT	Krajňák, A. (1); Galamboš, M. (1); Roskopfová, O. (1); Rajec, P. (1); Viglašová, E. (1) 1 - Department of nuclear chemistry, Faculty of Natural Sciences of Comenius University Bratislava, Slovakia
ENC2012-A0313	Bradwell FED Treatment Project	Fowler, A. (1); Hall, J. (1) 1 - Atkins, United Kingdom

ENC
2012

EUROPEAN NUCLEAR CONFERENCE



United Kingdom

MANCHESTER
9-12 December 2012

END OF USE

ENC
2012

EUROPEAN NUCLEAR CONFERENCE



United Kingdom

MANCHESTER
9-12 December 2012

END OF USE: TREATMENT/REMEDICATION

RADIOLOGICAL MAPPING WITH AN UNMANNED HELICOPTER

BERNARD ROTTNER

*Technical and Innovation Department, Onet Technologies
36 Boulevard de l'Océan, CS 20280, 13258 Marseille cedex 09 – France*

PIERRE TANTOT

*Presidency, Survey Copter
Route de l'aérodrome, 26700 Pierrelatte – France*

PIERRE PLANTIER

*Nuclear Measurement Department, Onectra
ZA Les Tomples, BP 45, 26701 Pierrelatte cedex – France*

ABSTRACT

In case of a nuclear accident with release of radio-nuclides into the environment, large areas require radiological mapping, before rehabilitation.

We designed a system able to scan such large areas, based on a gamma spectrometer mounted on an unmanned helicopter. This system, named "flying CRTT", is able to scan 6 hectares per hour with a 10m spatial resolution, or 300 hectares per hour with a 100m spatial resolution.

Using a helicopter avoids any problem of access, passing over the hedges, flying over the cliffs, without loss of time and without risks for human operators. The autopilot of the helicopter allows driving the system by a non qualified operator; only one week of training is required. The very high stability of the autopilot enables working under windy conditions (up to 15m/s), and also to fly very close (few meters) from the ground or from any obstacle (cliff, building...).

The standard detection threshold is 20 000Bq/m² of caesium (134+137). This value may be upgraded according to the specification. Thanks to the spectrometric capability of the detector, the measurement may address only ¹³⁷Cs, both isotopes of caesium, or ¹³¹I. Therefore, natural background has no influence on the result.

For mapping of big cities, flying CRTT may also be useful, mainly for high buildings, because this equipment accesses easily to the walls. But specific issues appear in this case, due to possible influence of other buildings than the one which is under scanning, and possible small gaps between different buildings. Our very stable autopilot, together with a specific collimator, addresses these issues.

This paper describes also the tests which were performed with our flying CRTT, and ¹³⁷Cs sealed sources placed in a field.

1. Introduction

The Fukushima accident reveals the need for large areas radiological mapping, including difficult to access areas, like wild areas, or cities with high buildings.

Onet Technologies, together with our partner Survey Copter, have developed a flying monitor for such purposes, based on its existing and proven technology for terrestrial automated mapping.

2. Previously existing technology

In 2003, Onet Technologies developed CRTT (French acronym for all surfaces radiological mapping), based on very high efficiency gamma detectors (plastic scintillators), mounted on an all surface carrier (see fig. 1), and connected with a Global Positioning device (GPS).

Once the surface has been scanned, the drawing the radiological map is just a push-button operation, which avoids any transcription error.

This kind of technology, with very low detection thresholds such as 500Bq/m^2 (^{60}Co) or 800Bq in a hot spot, has been successfully used for legacy CEA sites around Paris, and for the annual control of external roads on EdF NPP sites.



Fig 1: CRTT, terrestrial radiological monitor.

3. Flying Radiological Monitor

We extended the CRTT technology to a flying monitor using an unmanned helicopter, with a smaller detector (NaI scintillator, $3''\times 3''$), but with the same principle of coupling radiological data with position data.

The detector provides a spectrometric signal, which enables us to separate the background (cosmic rays, natural radio-nuclides) from the artificial nuclides (^{134}Cs , ^{137}Cs).

The stability of the helicopter has a dramatic influence on resolution of the mapping. If high resolution is required (typically 10m, or lower), then the helicopter has to fly at a low altitude (see fig. 2).

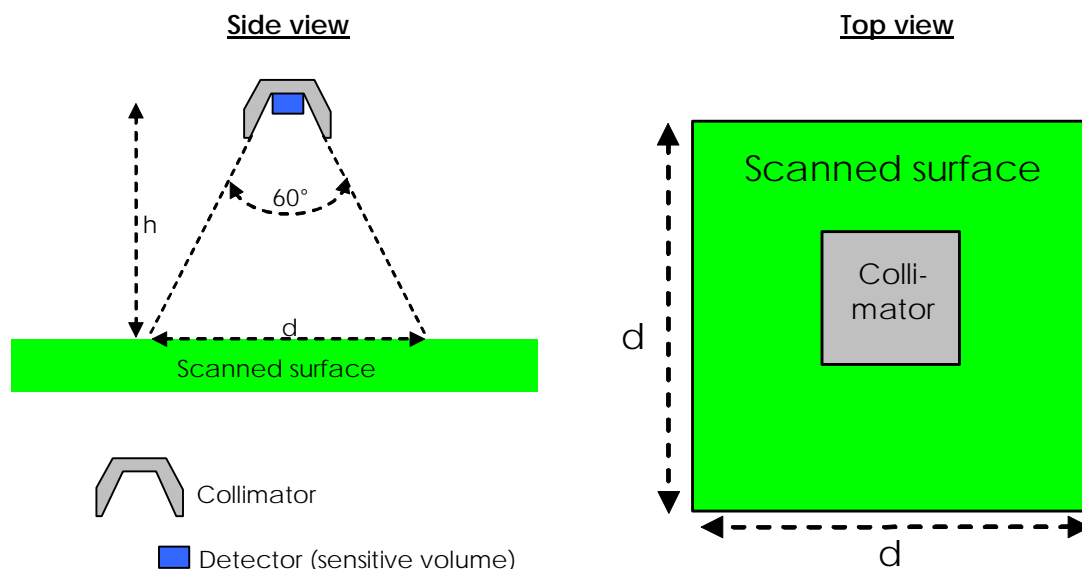

Fig 2: The spatial resolution is equal to the flying altitude.

High resolution requires stable flight, firstly in order to avoid any crash when flying at low altitudes, secondly to position the helicopter at the point to be scanned, and not some meters beside.

Therefore we choose Survey Copter as a partner for this technology: Survey Copter provides the best helicopter autopilots in the world, with a flying capability under winds up to 15m/s, and a stability better than 1m (see fig. 3).

The on board auto-pilot allows piloting the helicopter by an operator which is not a helicopter pilot: one week training is enough. The helicopter is remotely piloted through a joystick which allows very basic instructions: fly straight on, turn right, turn left, increase altitude, decrease. Automatic flying is also possible, for instance for an exhaustive scan of a defined area.

The helicopter drone is equipped with a camera which allows piloting the drone remotely, without direct vision.



Fig 3: Monitor flying under a 15m/s wind.

4. Results

We carried out real scale tests, using sealed ^{137}Cs sources placed on the airfield of Pierrelatte – France (see fig. 4). The results are summarized in table 1.



Fig.4: Real-time result of the radiological mapping.

Flying altitude (m)	Spatial resolution (m)	Detection threshold (Bq/cm ² , ^{137}Cs)	Scanning rate (km ² /h)
3	3x3	2.5	0.0052
10	10x10	2.6	0.058
30	30x30	2.8	0.52

Tab. 1: Performance versus flying altitude.

5. Radiological mapping of cities

Should radiological mapping of cities be required, the design of the flying monitor would be a bit more difficult, due to possible very complex geometries (see fig. 5).

Due to the fact that the background (interfering signal) may arise from the same radio-nuclides than the signal to be measured, the signal cannot be extracted from the background only with a spectrometry: a heavier shield is necessary.

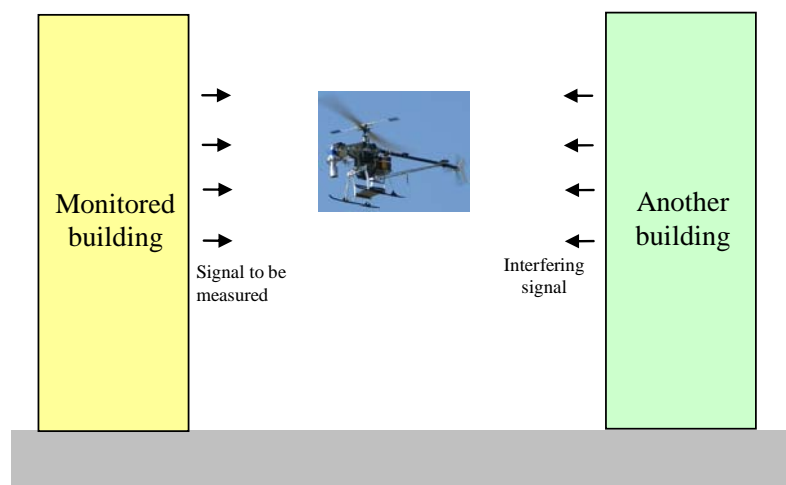

Fig.5: Example of a complex geometry

On the other hand, sometimes the monitor should scan a horizontal surface (streets, roofs of buildings), sometimes a vertical surface (walls of buildings).

Nevertheless, our studies show that radiological mapping of cities is possible with a flying monitor.

In this case, the stability of the helicopter is a crucial parameter, because it is required to fly very close to the surfaces (3 to 5m, maximum).

5. Conclusion

The feasibility of radiological mapping with an unmanned helicopter has been demonstrated, with real scale testing. Very large surfaces may be mapped, with high scanning rates, low detection threshold and high spatial resolution.

Compared to a manned helicopter, this technology avoids CO₂ emissions (electrical motor, or thermal motor with very low fuel consumption), and allows low flying altitudes, without risk of crash for the pilot.

Radiological mapping of cities is more difficult than of lands, but feasibility has been demonstrated, with paper demonstration.

TREATMENT OF EVAPORATOR CONCENTRATES FROM PWR

BERNARD ROTTNER

*Technical and Innovation Department, Onet Technologies
36 Boulevard de l'Océan, CS 20280, 13258 Marseille cedex 09 – France*

ABSTRACT

Evaporator concentrates from PWR are harmful towards the environment, both because of their radioactivity and their borates content. Cementation may be difficult because their main constituents are highly soluble salts, like borates and alkali salts. In addition, borates interact with cement.

We designed a two step process for treatment of the evaporator concentrates.

Within the first step, we extract the borates from the concentrates, as boric acid; the activity level in this boric acid is very low, and allows reuse in the power plant for reactivity control, or disposal as non radioactive waste (or very low level radioactive waste in France).

Within the second step, we melt the residual salts together with appropriate additives, in order to produce a non soluble solid matrix. The additives are carefully chosen in order to minimize the volume of final waste, to obtain a non soluble final waste, and to melt at a temperature less than 950°C.

Field experience is presented, showing incorporation ratio as high than 30, meaning that 30m³ of initial concentrate generates only 1m³ of final radioactive waste.

1. Introduction

Evaporator concentrates from PWR are harmful to the environment, both because of their radioactivity and their borates content.

Cementation may be difficult because their main constituents are highly soluble salts, like borates and alkali salts. In addition, borates interact with cement.

We designed a process, named SOGEBOR, which allows separating the borated compounds from the radioactivity, and immobilizing the radioactivity into a stable matrix.

The separation of the borated compounds from the radioactivity has two advantages: the borated compounds may be reused, or disposed of in a repository adapted for the chemical risks (repositories for radioactive waste are not always adapted for toxic chemicals), and the final volume of the radioactive waste is minimized.

This paper presents the good results of this process, from pilot scale experiments.

2. Overview of the process

SOGEBOR is a two step process for treatment of the evaporator concentrates (see fig. 1).

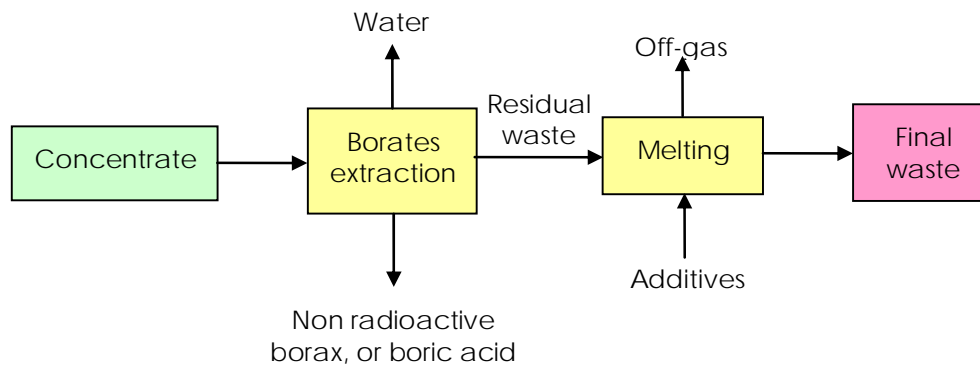

Fig 1: General principle of SOGEBOR.

Within the first step, we extract borates from the concentrates. There are several known extraction processes, based on dissolution/precipitation, steam stripping, or membranes [1]. We chose dissolution/precipitation because it extracts borates (mainly borax, which is sodium tetraborate), when other processes extract boric acid. Borax is a compound made of boric oxide and sodium oxide. Therefore the quantity of extracted dry matter is higher with this dissolution/precipitation process, and then the volume of final waste is minimized.

The activity level of extracted borax is very low, and allows reuse of the boric acid in the power plant for reactivity control (after processing the borax in order to produce boric acid), or disposal as non radioactive waste (or very low level radioactive waste in France).

After extraction of borates, the residual waste contains mainly alkali salts: nitrates sulfates, chlorides, and some residual lithium, sodium and potassium borates. The residual waste contains also non soluble compounds (sludge) like metallic salts, concrete powder, organics... The composition of this residual waste depends on the history of the unit (for instance past decontamination operations), and also on the PWR technology: for instance VVER use potash for neutralization of boric acid, when French PWRs use lithia. Therefore there is more lithium and less potassium in the French PWRs than in the VVER concentrate.

The target of the second step is to produce a non soluble solid with the highly soluble alkali salts, together with keeping the volume of the final waste as small as possible. Therefore we heat the residual waste up to melting, with appropriate additives. Heating reduces the quantity of waste by evaporation of water, incineration of organics, and thermal dissociation of nitrates and carbonates. The additives were selected in order to produce a non soluble solid. Melting occurs at temperature less than 1000°C. The melt is cast into 200 L drums.

The final product may be a glass or a synthetic rock (polycrystalline), depending on the selection and the quantity of additives. Glass has the advantage of requiring less additives, but has the drawback of splitting into small pieces during cooling down. However, a waste under the form of split pieces of glass is not directly compliant with acceptance criteria of surface repositories (for LLW and ILW waste), which generally require that the waste shall be immobilized into a solid block.

3. Borates extraction

The solubility of borax varies dramatically with the temperature: from 1.23% at 0°C (ratio of the weight of $\text{Na}_2\text{B}_4\text{O}_7$ to the weight of solution) to 28% at 100°C [2]. Therefore, it is possible to extract borax by concentrating the initial waste at 100°C and precipitating it at low temperature (see fig.2). Borax is purified during precipitation.

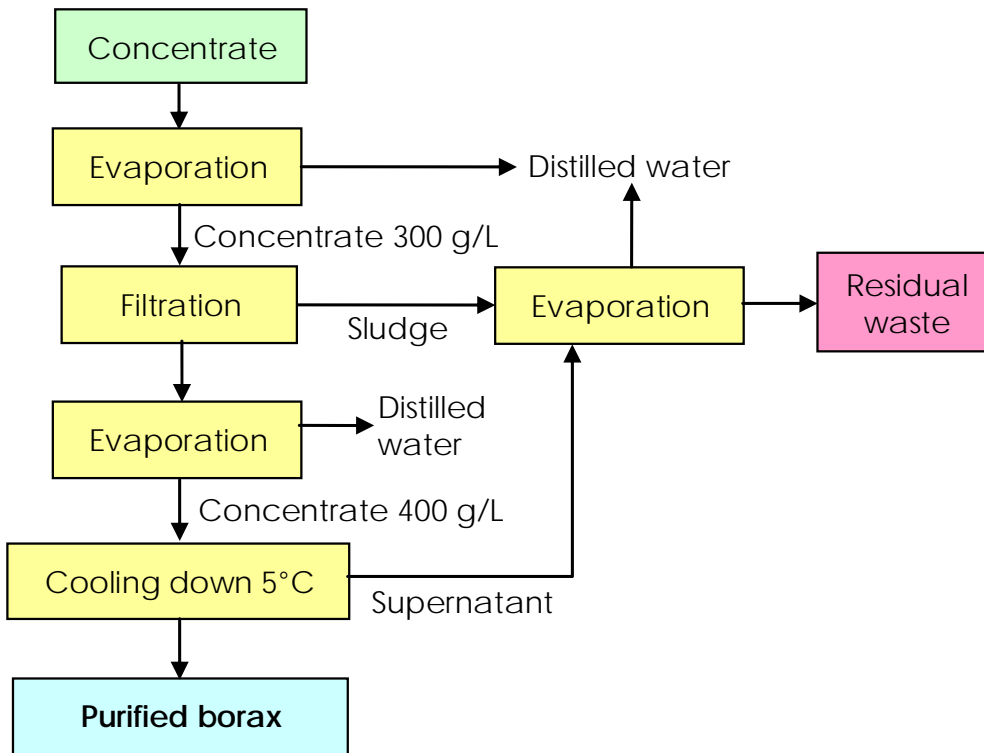

Fig 2: Borax extraction with one step dissolution/precipitation.

Boric acid forms with soda many different borate species, depending on the Na/B ratio: H_3BO_3 , NaB_3O_5 , $\text{Na}_2\text{B}_4\text{O}_7$ (borax), NaB_4O_7 , NaB_5O_8 , NaBO_2 ... As the solubilities of these species are different, the solubility of borates depends strongly on the pH (see fig. 3).

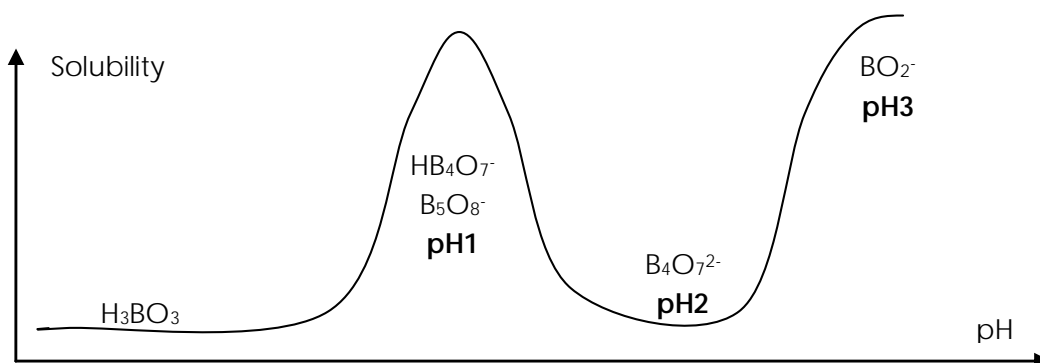

Fig 3: Solubility of borates with respect to pH at room temperature.

pH2 is around 9.2 and corresponds to borax. In order to have the greatest ratio between solubility at low temperature and solubility at high temperature, we have to adjust the pH in the concentrate so that borates are under borax form.

According to the level of residual radioactivity allowed in the purified borax, one or several steps of dissolution/precipitation are necessary (see fig.4).

The table 1 gives the decontamination factors per precipitation/dissolution step.

TABLE I. decontamination factors per step				
Cs	Fe, Ni, Co, Sr	I	Organic ¹⁴ C	Inorg. ¹⁴ C
40 to 150	20 to 100	10 to 50	30 to 120	10 to 30

Iron DF is very sensitive to the quality of filtration. Highest DFs were obtained with tangential filtration with membranes, with porosity around 0.1µm.

Organic molecules may chelate non alkali metals (Co, Ni, Fe, Sr): when chelated, the metal is in solution and is separated when the borax precipitates, and when not chelated, the metal is separated during filtration.

4. Melting

We carried numerous laboratory tests in order to select a target composition (residual waste from borate extraction, with additives) which presents the following characteristics:

- Non soluble final product: Solubility and measurement of weight loss have been checked through immersion into distilled water during 6 months. Our criterion was a loss of weight during the first days of less than 5%, and an additional loss of weight of less than 0.5 % during 6 months. It is possible to adapt the target composition, changing the amount of additives, to improve leachability if required by other standards,
- As high as possible incorporation ratio: This ratio is defined as the amount of initial waste (for instance 50g/L concentrate) divided by the volume of the final product,
- Processing temperature less than 1050°C: at higher temperatures, borates and alkali oxides (including caesium) volatilize. Lower temperatures enable the use of cheaper technologies for the furnace and for the off-gas treatment,
- If possible, the final product should be under polycrystalline form (synthetic rock), so that it does not split into small pieces during cooling down.

We reached 2 compositions: composition 1 (table IIa) is a glass, but has a higher incorporation ratio, composition 2 (table IIb) is a synthetic rock:

TABLE IIa. Target composition 1 (% weight)					
Na ₂ O	K ₂ O	B ₂ O ₃	SiO ₂	Al ₂ O ₃	CaO
7,74	23,52	17,38	22,50	6,36	3,53
MgO	BaO	ZnO	ZrO ₂	Other	
1,28	4,78	10,16	2,56	0,18	

TABLE IIb. Target composition 2 (% weight)					
Na ₂ O	K ₂ O	B ₂ O ₃	SiO ₂	Al ₂ O ₃	CaO
6,71	20,41	15,08	19,52	5,52	3,07
MgO	BaO	ZnO	ZrO ₂	Other	
1,11	4,15	22,04	2,22	0,16	

Na₂O, K₂O, B₂O₃, others (oxides of multivalent metals) and a part of CaO and MgO come from the raw waste, and the other compounds are additives.

One 200 L drum of final product of composition 1 contains the residual waste arising from the treatment of 26,3 m³ of 50 g/L concentrate.

One 200 L drum of final product of composition 2 contains the residual waste arising from the treatment of 22,8 m³ of 50 g/L concentrate.

Composition 1 is obtained by melting at 975°C, and composition 2 at 950°C. In both cases samples degas and produce foam during heating. Therefore, the heating procedure shall be optimized (see next section: "technologies").

Degassing arise from water evaporation, combustion of organics, and nitrates and carbonates thermal dissociation. And degassing generates foaming

5. Technologies

5.1 Borates extraction system

We built a pilot scale system in order to test the process, firstly on non radioactive simulated waste and secondly on radioactive waste, on batches of about 20 kg of initial dry raw waste (see fig. 5).



Fig.5: Pilot scale system for borate extraction.

This pilot unit has been successfully tested. Results presented in table I where obtained with this unit.

5.2 Melting furnace

We selected the microwaves heating technology because it allows a quick melting (within less than 1 hour for a 450kg / 200L batch), together with an easy stirring of the heated product: the microwaves are injected into a rotating crucible (rotation creates stirring). See fig. 6. Stirring during heating is very important because it allows an easy degassing and then avoids foaming.

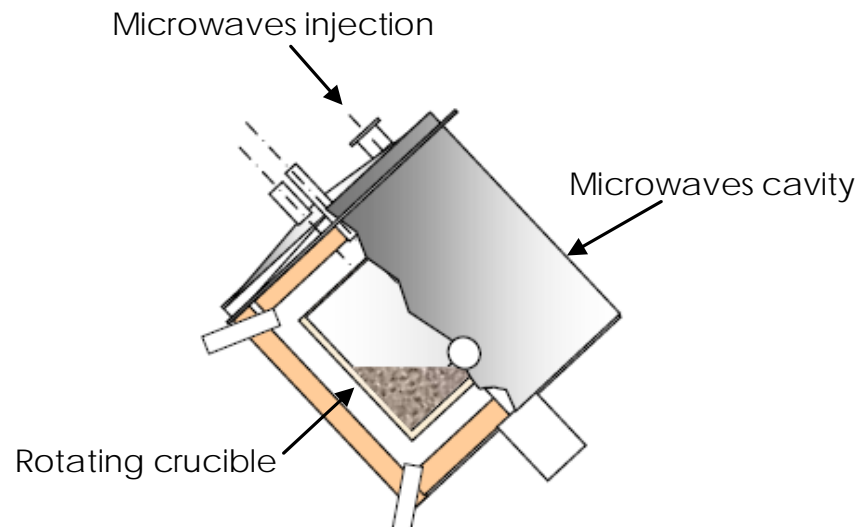

Fig.6: Microwaves furnace.

We successfully tested the melting process at a pilot scale (10kg of final product). See fig. 7.



Fig.7: sample of final product.

At industrial scale, we melt firstly a small amount of compound, about 20kg, and then add continuously the raw compound, until reaching a 450kg / 200L melt. This procedure avoids foaming and facilitates off-gas treatment.

Then we cast the melt into a 200L drum. Once cooled down, the drum may be disposed of into a final repository, directly or after over-packing, depending on the activity and the local specifications for final waste.

In some cases, we produce a glass, which splits during cooling down, and then grout the pieces of glass for final disposal.

5.3 Off-gas treatment

The off-gas treatment system uses proven and commercially available technologies:

- Off-gas cooling down by mixing with cold air, or by water injection,
- Decloggable bag filters: the collected dust is re-injected into the crucible,
- HEPA filters. They are protected by the bag filters and do not require frequent replacement,
- Scrubber, for acid gases capture. The scrubber produces a non radioactive waste water.
- "Denox": reduces NO_x into nitrogen,
- Controls: dust, CO, VOC, NO_x, SO_x, radioactivity.

6. Conclusion

SOGEBOR is a process treatment of evaporator concentrates from PWR which combines recycling of a part of the waste, high quality final product, and very high incorporation ratios: the final waste arising from the treatment of 26m³ of 50g/L concentrate is conditioned into one single 200L drum.

The process has been successfully tested at pilot scale.
Industrial scale unit is under design and manufacturing.

5. References

- [1] IAEA TECDOC 911: "Processing of nuclear power plant waste streams containing boric acid",
- [2] Handbook of Chemistry and Physics – David R. Lide editor, 83rd edition – 2002 - 2003.

STRONG AND WEEK DEPENDENCIES WHEN CALCULATING ACTIVITIES OF WASTE FILLED DRUMS

M. KRÖHN, M. SOKCIC-KOSTIC, F. LANGER, R. SCHULTHEIS

*Nukem Technologies GmbH
Industriestraße 13, 63755 Alzenau - Germany*

ABSTRACT

In order to investigate the effect of filling degree and density on the activity estimates, Monte Carlo simulations have been carried out with different system models. Initially the expected countrate Z for a given activity A , density $ro = const$ and gamma energy $E = const$ has been calculated, depending on different filling degrees f . This yields a bijective relationship

$$A = Z / eps(f)$$

where $eps(f)$ is the filling dependent linear proportionality.

In real measurement scenarios the filling degree is assumed constant, because determining this property by measurement is often not applicable (e.g. employing x-ray). A common guess is complete filling. In order to quantify the deviations from initial activities, new activities have been recalculated from the above countrates using constant $eps(f=100\%)$. Results differ in the range of few percents with initial filling ranging from 50% to 100%, yielding that a poor guess on filling degree has only weak influence on the overall result.

Next the effect of matrix density is investigated, which governs self absorption in the drum. A way to determine density by measurement is to divide measured weight of the drum by its volume V , assuming complete filling. Therefore the same calculations as above where made with density-dependent $eps(ro)$, with

$$ro = f / V$$

as the reduced density. Deviations between initial and recalculated activities yield 21% for 75% filling and 47% for half filling.

The influence of a poor guess on density therefore is significantly higher than that of a poor guess on filling itself. Hence deriving densities from measurement should only be done if the filling degree is well known.

Introduction

Gamma detectors are a vital part of radiological measurement systems when it comes to directly or indirectly identifying isotopes or to ensure that limits for storage regulations are met [1,2]. A wide range of detector types exist to fulfill these tasks.

In a well defined measurement scenario, one can link the countrate gathered by a detector at a certain distance to the activity of the specimen, e.g. a drum filled with radiological waste. Well defined means that composition of the waste is known, i.e. the distribution of the waste in the overall matrix (homogenous, point source(s), etc.), filling degree and matrix density. With that entire knowledge one can then model the measurement situation and derive a linear relationship between count rate and activity for distinct gamma energies.

In real life most of these facts are replaced by assumptions on the system, because one can not take a look inside a waste drum. System models therefore base on idealised

characteristics like full homogeneity. Hence the proportionality between count rate and activity may deviate from reality.

Figure 1 illustrates the result of a monte carlo simulation where a detector (1) shielded by a collimator housing (2) faces a drum containing homogenously distributed waste (3).

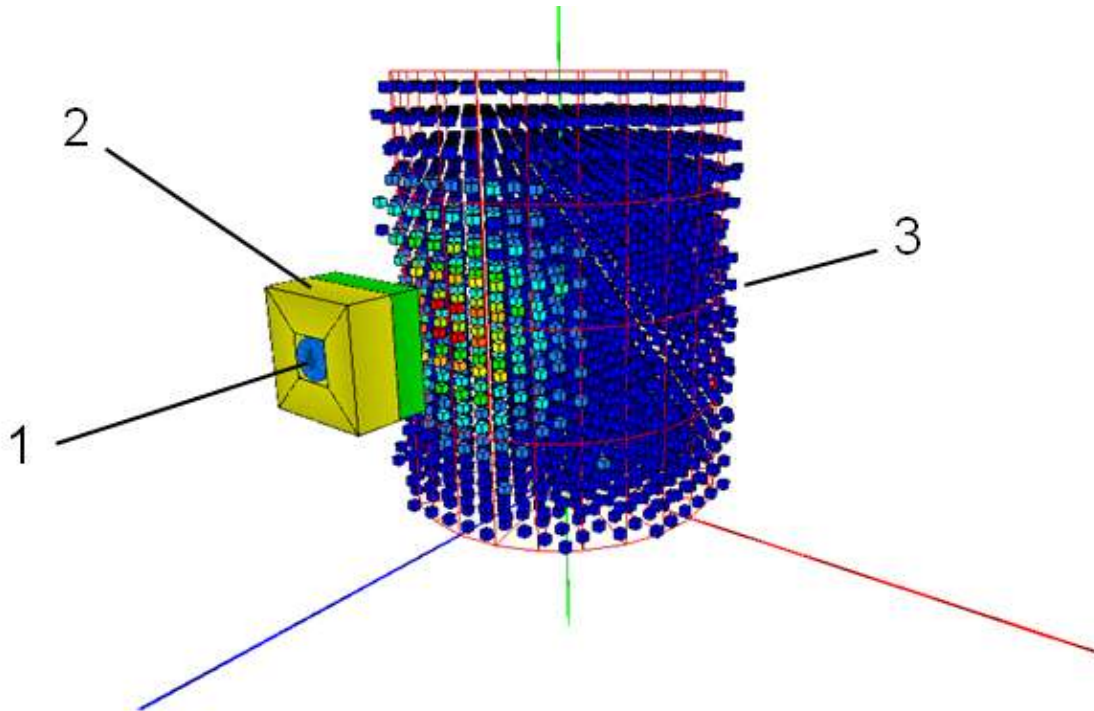

Figure 1: ISO-Mod simulation scenario with homogenous drum (3) and collimator (2) shielded detector tube (1).

The homogeneously filled drum is represented by equally spaced gridpoints with constant specific activity. The contribution of each gridpoint to the overall detector count rate is colour-coded: Red colour symbolises major contribution while blue colour stands for minor contribution. The calculation yields the relationship between overall count rate and waste activity. Various scenarios (e.g. different filling or waste densities) can be modelled and compared.

This paper presents a quantification of the deviations that occur, when misjudging filling degree or overall density of the drum content. Results were obtained using the Monte Carlo Simulation program ISO-Mod by Nukem Technologies GmbH.

Methodology

Monte Carlo Simulations are capable of characterising radiological measurement scenarios, considering geometries, densities and attenuation coefficients of drum content, drum body and collimators, as well as detector properties like dimensions and detector response [3].

An implementation of the standard methodology was realised with the Nukem Software ISO-Mod, that is capable of characterising different and dynamically changing measurement scenarios [4]. It connects the count rate A_{count} measured by a detector with the activity A_0 of the source (homogeneous distribution or point source), taking into account the detector

response W_A , the measurement geometry and mass attenuation mu_i and density ro_i of the materials involved with beam intersection length x_i , as shown in equation (1).

$$\frac{A_{count}}{A_0} = \frac{W_A}{4\pi} \int_{Source} dV' \int_{Frontcap} dF \frac{1}{|r-r'|} \prod_i \exp\{-mu_i ro_i x_i\} \quad (1)$$

ISO-Mod generates an ensemble of rays and calculates the detection propability for each by solving equation (1) and the detector efficiency by summing over all rays.

In the following sections given countrates will be assumed, derived from a general case, from which activities are recalculated and compared to the initial general case. W.l.o.g. the calculations will be carried out for a single gamma energy, here 661,7 keV, referring to Cs-137. The measurement scenario is kept simple, including a homogenously filled standard waste drum and a detector at a distance of one meter. No collimators are modelled. The detector response was derived experimentally beforehand.

First a general case is constructed linking initial acitivities to countrates depending on the filling degree f . Then the influence of a wrong estimate on filling degree and on density is examined seperately, comparing these calculations to the general case.

General Case

Table 1 features simulation results for countrates at given activities.

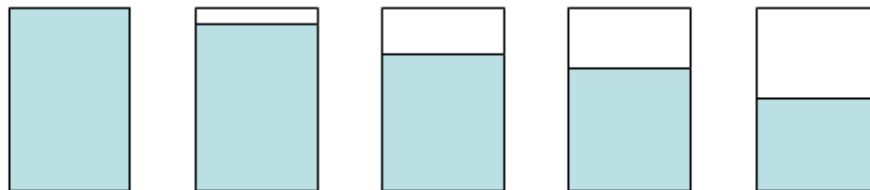

Filling degree	1	0,825	0,75	0,675	0,5
Source activity	1	0,825	0,75	0,675	0,5
Ratio <i>eps</i>	7,85E-06	7,99E-06	8,04E-06	7,98E-06	7,75E-06
Countrate	7,85E-06	6,99E-06	6,03E-06	4,99E-06	3,88E-06

Tab 1: Simulation results for the general case.

The activity is assumed to be homogenously distributed throughout the drum. Therefore the activity decreases with lower filling degree. Activity and filling degree are given in reduced units. Countrate and ratio, i.e. countrate divided by activity, are derived from simulation.

In real measurements activities are calculated from measured countrates using a suitable ratio *eps*. The most accurate *eps* to do so is the one from Table 1. As stated in the introduction, this ideal situation cannot be reached because of unknown circumstances like filling degree and density. The two most common approaches to overcome the situation are:

- Using a constant density (e.g. 2 g/cm³) and constant filling degree (e.g. 100%)
- Calculating density from mass of drum, assuming constant filling degree (e.g. 100%)

The following will examine the two assumption and show which one has the bigger impact on the result.

Dependency on filling degree

Constant density and filling degree result in a constant ratio *eps*. From the countrates of Table 1 activities can be recalculated with the new *eps*. Table 2 shows deviations of recalculated from original activities.

Filling degree	Activity	Ratio <i>eps</i> (E,ro)	Countrate	Recalculated activity using ratio <i>eps</i> for filling degree = 1	Deviations
1	1	7,85E-06	7,85E-06	1,00	0,0%
0,875	0,875	7,99E-06	6,99E-06	0,89	1,8%
0,75	0,75	8,04E-06	6,03E-06	0,77	2,4%
0,625	0,625	7,98E-06	4,99E-06	0,64	1,7%
0,5	0,5	7,75E-06	3,88E-06	0,49	-1,3%

Tab 2: Comparison between original and recalculated activities with constant density and complete filling.

From Table 2 it can be seen that even if the drum is only half filled, using a constant filling degree of 100% only slightly influences the result when assuming the correct density.

Dependency on density estimate

Now the actual density is calculated from mass divided by drum volume. Incomplete filling then results in wrong estimates, ranging from 1 g/cm³ to 2 g/cm³. This also yields wrong ratios *eps*.

Filling degree	Activity	Countrate	Ratio <i>eps</i> (E,ro)	Recalculated activity using density dependent <i>eps</i> (E,ro)	Deviations
1	1	7,85E-06	7,85E-06	1,00	0,0%
0,875	0,875	6,99E-06	8,89E-06	0,79	-10,1%
0,75	0,75	6,03E-06	1,02E-05	0,59	-21,2%
0,625	0,625	4,99E-06	1,20E-05	0,42	-33,5%
0,5	0,5	3,88E-06	1,45E-05	0,27	-46,6%

Table 3: Comparison between original and recalculated activities for different density estimates assuming complete filling.

Table 3 shows the deviations between original and recalculated activities, that are up to 46,6% for half filled drums. In general activities are underestimated because lower densities mean less absorption in the material.

Conclusion

From this one can conclude that an estimate of the filling degree - good or poor - only weakly influences the result, while assuming wrong densities strongly changes the outcome, most likely in a way that actual activities are underestimated. Hence deriving densities from measurement should only be done if the filling degree is well known. Otherwise a good guess on densities considering waste composition should be preferred, e.g. 2 g / cm³ for radiological waste concealed in a concrete matrix.

Acknowledgements

The authors would like to thank Dr. Rolf Leicht for valuable comments and discussions.

References

- [1] M. Sokcic-Kostic, R. Schultheis; Radiological Characterisation of Radioactive Solid Waste by Gamma Measurement; Jahrestagung Kerntechnik 2008
- [2] M. Sokcic-Kostic, R. Schultheis; Radiological Monitoring Systems for waste Characterisation in the Environment of our decommissioning Solutions; Proceedings of the 12th International Conference on Environmental Remediation and Radioactive Waste Management, ICEM09, 2009
- [3] The Panel on Gamma and Electron Irradiation Modeling Working Group; Review of Monte Carlo Modelling Codes; The Irradiation Panel 2007, 2010
- [4] M. Kröhn, F. Langer, M. Sokcic-Kostic; Modeling dynamically changing measurement scenarios for Gamma Spectroscopy; *to be published*, 2013

INNOVATIVE APPROACH FOR FIRE RISK ANALYSIS DURING DESIGN STAGE FOR NON REACTOR NUCLEAR FACILITIES

A. Traichel, M. Mummert, M. Dilger
*Department Safety Engineering and Assessment
NUKEM Technologies GmbH
Industriestrasse 13
D-63755 Alzenau
Germany*

Abstract

In the framework of international agreements for construction of nuclear waste handling and storage facilities it is necessary to establish fire protection analysis according to the country-specific laws. The fire safety concept is mandatory for licensing. This concept needs to include measures to meet the safety objective regulations for internal and external hazards. With commonly used deterministic fire safety concept malfunctions are prevented and mitigated. There are several strategies for the development of fire safety concepts. The person in charge has a great responsibility to choose the suitable one for the project. The innovative approach will solve these problems, and give the person in charge a working tool with a simple step-by-step sequence for all the important concept phases. With this fire safety approach it is possible to create fire safety concepts in a convenient and timesaving way. With the results from the probabilistic analysis during the design stage the deterministic concept will be improved. Expenditure and later revision steps are therewith minimized. The approach has been derived from the general concept for nuclear power plants and was customized for non-reactor nuclear facilities. A Software "I.Care.fire" (Identifying critical areas and risk evaluation) was created to support the designer during this challenging task. The software distinguishes between fire compartments and fire areas. This involves the "screening", whilst all the rooms relevant for a fire are appointed and all the rooms with a low fire load are neglected. Furthermore the probabilistic fire safety analysis program involves the generation of "event trees" and their analysis. This analysis will provide detail information about the rooms with the highest hazard probabilities for a fire occurrence and for the propagation of fire to adjacent rooms. Probabilistic fire risk analysis for non-reactor nuclear facilities is a time saving and innovative working tool. At first this approach was applied to distinguish between the critical areas of nuclear waste treatment facilities in a European country. This approach offers a promising extension of the detail analysis based on event tree analysis for identifying and resolving potential weak spots of the fire safety concept during the design stage. These standards will be applied to future projects for non reactor nuclear facilities to comply with the high safety standards in this field of work. With the given concept it is also possible to implement a dynamic fire safety concept adjustment. This adaption can be applied during the design stage as well as during operation and decommissioning. It provides a fast inspection of the fire relevant inventory and the possibility to adapt fire areas and fire zones. Because the system is computer based, the documentation of the individual modifications is convenient and traceable.

1. Introduction

The global intention for the development of the software was to enhance the safety of non-reactor nuclear facilities during design and realisation of fire protection arrangements in the area of decommissioning and disposal. To fulfil the high safety requirements in nuclear technology it is mandatory to provide a fire protection concept included in the deterministic safety analysis for the administrative approval for the construction of e.g. waste treatment facilities. The highest priority is the protection of the people and the environment from the harmful effects of radioactive material. In addition to the essential deterministic safety analysis it is for the first time that a probabilistic fire risk analysis for a non-reactor nuclear facility is performed in the design stage. By means of the Fire-PRA it is possible to detect and evaluate weak spots and give an extensive impression about the balance of the planned fire safety concept.

The Fire-PRA is a well understood and documented tool for fire safety concepts in nuclear power plants. The German “Gesellschaft für Anlagen und Reaktorsicherheit (GRS)” [1] and the German „Bundesministerium für Umwelt, Naturschutz und Reaktorsicherheit (BMU)” [2] provide an extensive documentation for the procedure of a Fire-PRA in a nuclear power plant. By incorporating the state of technology, the following problems derive for Fire-PRA of non-reactor nuclear facilities.

- Adaptation of the approach for the realisation of a Fire-PRA,
- Verification of the accuracy of the Fire-PRA,
- Supply of reliable fire specific Information.

2. Basic deterministic approach for fire risk analysis

The development of an optimised design procedure for the realisation of a fire safety concept for non-reactor nuclear facilities is principally based on the regulations of the German nuclear standard KTA 2101.1 “Fire Safety in Nuclear Power Plants” [3] and requirements by the International Atomic Energy Agency (IAEA) as given in [4].

For the declaration of fire areas, fire fighting areas and spatial separations by doors with defined fire resistance levels, it is necessary to develop a fire load list for the whole facility.

A special consistent documentation sheet including additional room/fire specific information has been prepared to standardise the fire load list.

This concept allows the segregation of the facility into fire compartments and sub-compartments. The fire resistance rating of the individual fire barriers, such as walls and ceilings, and their elements (doors, dampers, etc.), separating fire compartments and access and rescue routes needs to be determined.

Another important issue during the creation of the fire safety concept is the design of the escape routes. The following individual points have to be discussed in detail.

- Design of the escape staircases,
- Design of the secure area “corridor”,
- Smoke extraction system,
- Lighting systems
- Escape routes signs

The fire detection systems and the fire extinguishing systems are particularly important in the fire protection concept. To implement this fire safety concept a comprehensive step by step procedure combined with a detailed documentation of all the relevant passages was developed. In the fire protection plan it is sufficient to document the intended use, the important process steps as well as the dimensions of the room.

The individual steps are based on the procedure specified by the German Nuclear Safety Standards Commission “KTA” and the Model Building Regulations “MBO” [5]. The general approach, as well as the design of the concept, is independent of system and manufacturer. During the detail design of the fire protection concept, system specific differences are included.

3. Innovative probabilistic approach for fire risk analysis for non-reactor nuclear facilities

The Fire-PRA can identify weak spots in the planned safety levels derived from the deterministic fire safety analysis and possible solution concepts can be tested. During the screening process, all the rooms with a fire load below a certain level are excluded from further discussion. The fire outbreak probability is calculated for every room. This probability depends on the amount of mechanical and electrical equipment, the distribution of the inflammable material in the room and the ignition temperature. The parameters for the development of a fire are calculated. Those parameters depend on the fire fighting arrangements, the spatial enclosure of the room and the persons in the room or neighbouring area. The rooms are ranked according to their fire outbreak probability, fire development parameter and fire load. The results from the screening process are the bases for the fire specific event tree analysis.

Due to the high complexity for the implementation of a Fire-PRA in the area of decommissioning and nuclear waste treatment facilities a software program has been developed to support the person responsible for fire protection design. The following necessary steps are simplified by the software:

- Screening process,
- Fire specific event tree analysis.

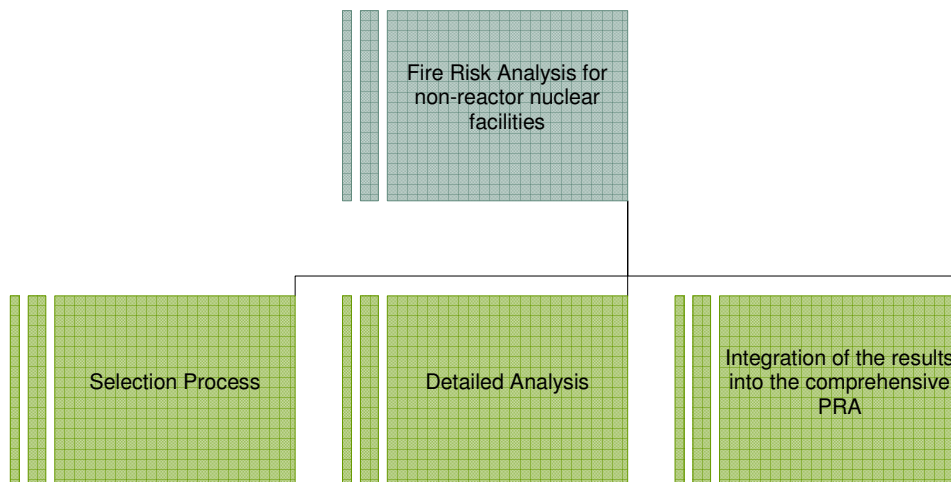

Figure 1: Main Steps of performing a fire risk analysis

According to Figure 1 the three main steps of performing such an analysis are the following:

- Selection of the relevant rooms. The selection process is necessary to determine the set of rooms, for which it is necessary to perform a detailed analysis. It would take an excessive amount of time and effort to analyse all rooms, so it is obviously useful to exclude some of them from the further investigations.
- Detailed analysis for the relevant rooms. The objective of this section is to determine the probabilities of the occurrence and spread of fire, and the related failure probabilities of certain devices of the facility.
- Integration of the results of the fire-PRA into the comprehensive PRA model of the facility (if this exists).

After integrating the results, it is possible to estimate the influence of the potential fire-caused failures, concerning the security status of the whole facility.

4. Optimisation of the probabilistic fire risk analysis with the software “I.Care.fire”

The person in charge is supported by the software “I.Care.fire” (Identifying critical areas and risk evaluation) for the difficult task of identifying critical areas and the part of event tree analysis.

Important parameters like the

- Fire outbreak probability of the room or area i ,
- Parameter for the characterisation of the ignition sources in the room i ,
- Parameter for the starting of a fire in the room i ,
- Fire development parameter 1,
- Fire development parameter 2,

are calculated and can be exported by the software.

5. Summary

In addition to the essential deterministic safety analysis it is for the first time that a probabilistic fire risk analysis for a non-reactor nuclear facility is performed in the design stage. To enhance the safety of non-reactor nuclear facilities during design and realisation of fire protection arrangements in the area of decommissioning and disposal, software has been developed for the improvement of the screening and ranking process. This approach leads to faster and more reliable fire safety analysis during the design stage of non-reactor nuclear facilities.

6. References

- [1] Hofer, E., M. Röwekamp, M. Türschmann: Fortschrittliche Methoden für eine Brand-PSA, Entwicklung fortschrittlicher Methoden zur realitätsnahen Durchführung anlagenspezifischer probabilistischer Brandrisikoanalysen, Gesellschaft für Anlagen und Reaktorsicherheit (GRS) mbH, GRS-190, ISBN 3-931995-58-5, Köln; Juli 20033
- [2] Türschmann, M., M. Röwekamp, J. von Linden: Systematisches Auswahlverfahren für probabilistische Brandanalysen, Schriftenreihe Reaktorsicherheit und Strahlenschutz, BMU-2005-667; 22005
- [3] Kerntechnischer Ausschuss (KTA): Sicherheitstechnische Regel des KTA: KTA 2101, Brandschutz in Kernkraftwerken, Teil 1-3, Fassung 12/00; Dezember
- [4] International Atomic Energy Agency (IAEA): Preparation of Fire Hazard Analyses for Nuclear Power Plants, IAEA Safety Reports Series, No. 8, Vienna, Austria, 1998
- [5] MBO, Musterbauordnung - MBO - Fassung November 2002, <http://www.isargebau.de/lbo/VTMB100.pdf>

Compact incineration systems for thermal treatment of radioactive waste

Rainer Slametschka, NUKEM Technologies GmbH, Alzenau

Klaus Büttner, NUKEM Technologies GmbH, Alzenau

Dr. Gebhard Schetter, Dipl.-Ing. Ruppmann Verbrennungsanlagen GmbH, Stuttgart

1. Types of low and intermediate level radioactive contaminated waste

Different types of waste are produced during the operation of a nuclear power plant. The waste can be direct from operation such as contaminated working cloth for example or wood during maintenance. The following composition of waste is an average value of different power plant and was used for the design of the incineration plant.

Type	Elementary analysis	Heat value /4/	content
		[MJ/kg]	[%]
Paper, wood, cellulose	$C_6 H_{10} O_5$	17	52,4
Plastic (PE)	$C_{100} H_{202}$	46,1	29,4
PVC	$C_2 H_3 Cl$	18,0	4,6
Water	H_2O	-2,3	12,7
Inters		0	0,9
Heat value (total)		23,0	

Tab. 1: Combustible Waste

In future the range of waste is extended with liquid waste, such as oils etc..

2. Thermal treatment in a multi-chamber incinerator

Based on the above described types of waste, in a first step the calorific values were calculated for different waste compositions, which yield to a mean calorific value of 23 MJ/kg and a range between 18 and 25 MJ/kg. With respect to economic incinerator design, the incineration capacity is defined for two variants, 50 kg/h and 25 kg/h. These design criteria leads to the heat release diagram as shown in fig. 1.

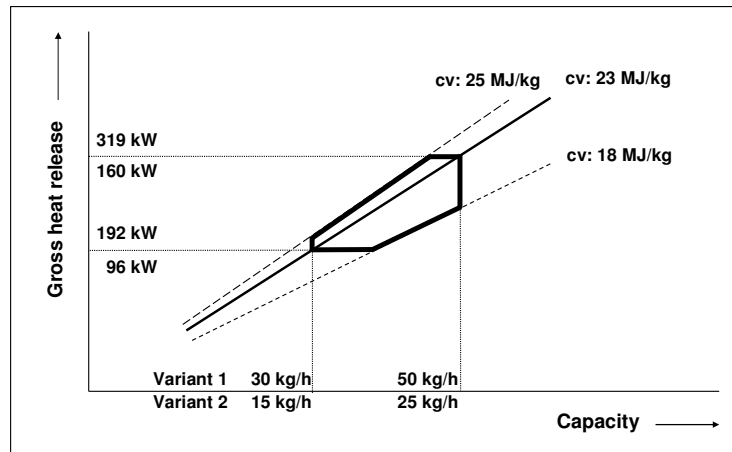

Fig. 1: Heat release diagram as design basis for the incinerator

According to environmental protection standards, such as given by the Directive 2000/76/EC of the European Community, incinerators shall be designed in such a way that flue gas from post combustion, i. e. after the last injection of combustion air, should be under the most unfavourable conditions at a minimum temperature of 850 °C for at least two seconds. In case of chlorine content of more than 1 % in waste material a minimum post combustion temperature of 1100 °C has to be achieved instead of 850 °C. Based on data analysis of the nuclear waste material, the chlorine content exceeds the limit of 1 % in most cases. Applying combustion calculation to the above mentioned nuclear waste composition leads to a specific flue gas quantity of about 13.4 m³_N/kg waste input. As a consequence the required post combustion volume in case of variant 1 (50 kg/h) has to be designed to be in the order of 1.9 m³, respectively 0.95 m³ for variant 2.

The incineration unit, which is designed as an indoor system, is fed from above using a closed waste feeding chute. This multi-chamber incinerator (fig. 2) consists of a furnace (main combustion chamber), an ash burnout zone and a flue gas post combustion chamber, which is divided into three passes equipped with secondary air nozzles in the first and a post combustion burner in the second pass. Within the third pass, arranged in lateral way to the second one, the flue gas flow is homogenised.

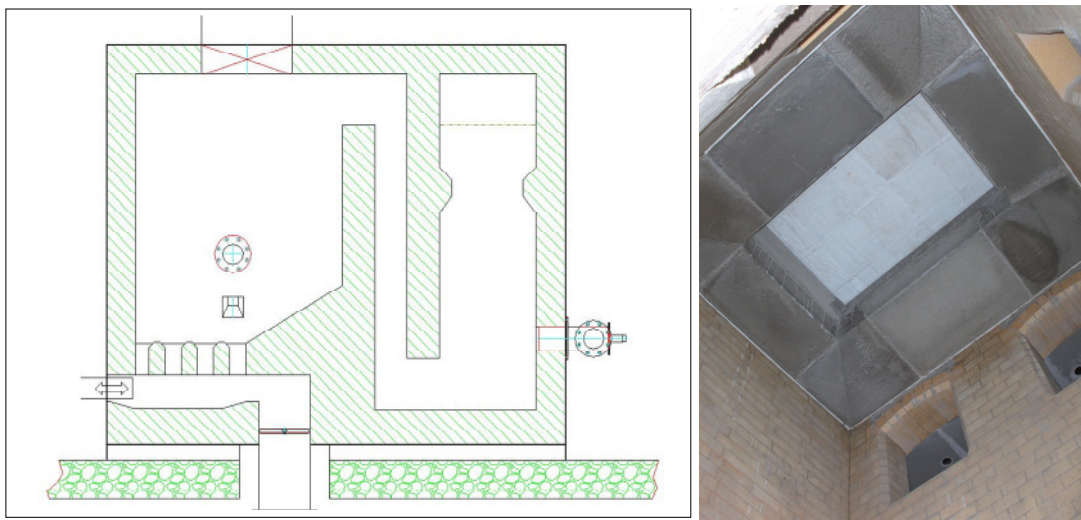

Fig. 2: Incineration unit – design and view from inside the furnace

This basic construction leads to a highly effective burnout of solid residues (furnace ash) as well as flue gas. The burnout of solid material is achieved by an interaction of the different process steps such as drying, gasification, ignition, primary combustion and burnout of the solid residues. These process steps are reinforced by flame radiation of auxiliary firing in combination with heat radiation from the furnace walls. The required combustion air is injected via a set of primary air nozzles which ensures that the unburned gaseous products react with primary air. The remaining furnace ash is taken out from the incinerator via a rotating plate to an ash container for final disposal. The post combustion of the flue gas arising from furnace takes place first in a constricted duct under high turbulence conditions and supported by a well-proven arrangement of the air nozzles. In the second pass the flue gas is held at the required temperature level by a gas-fired post combustion burner, which is arranged in such a way to generate rotation of flue gas whereas in the last pass is designed as a tranquilisation zone. All process steps are observed and controlled automatically by a programmable logic control system (PLC system) and combined with a data monitoring system.

In accordance to the emission limitations of carbon monoxide (CO) and total organic carbon (TOC) the incineration process has to be focused on high efficiency. In practice, the combustion of heterogeneous material is operated under conditions of an excess rate of oxygen, respectively of combustion air. On the other hand, excess air is a burden for the combustion process in fact of supplementary flue gas volume, which does not participate in combustion, but has to be heated, whereby the resulting combustion temperature is reduced. In this context, combustion processes can be explained in a qualitative way as in fig. 3. From practical experience during combustion of heterogeneous material, local and temporal varying areas of oxygen deficiency can appear which, despite high local combustion temperatures, may lead to incomplete combustion ("hot" CO). In contrast, too much excess of oxygen decreases the activating energy and in turn the characteristic combustion temperature so that the second partial reaction, the development of CO to CO₂, is being constrained ("cold" CO).

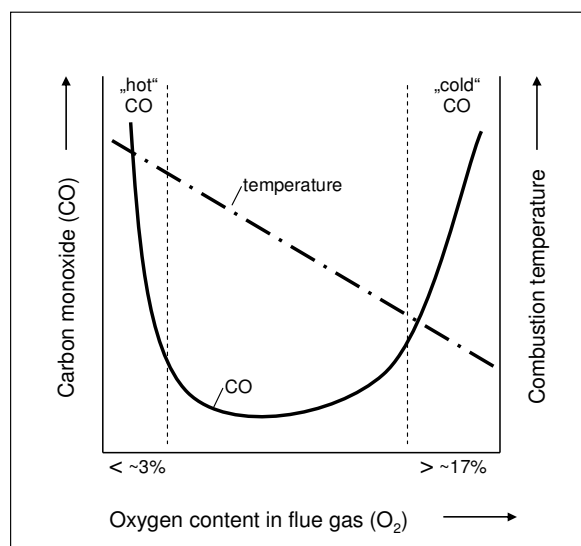

Fig. 3: Qualitative relationship in combustion processes (acc. to /1/)

3. Off gas treatment

To achieve all regulatory requirements for the release of off gas to the environment several steps for cleaning are provided. The following tabulation shows the major criteria for the release of the off gas besides the radioactivity.

Condition	
SO ₂ [mg/Nm ³ , dry]	< 50
HCl [mg/Nm ³ , dry]	< 10
Dust [mg/Nm ³ , dry]	< 30
Dioxines and Furanes [ng/m ³]	< 0,1

Tab. 2. Regulatory requirements /3/

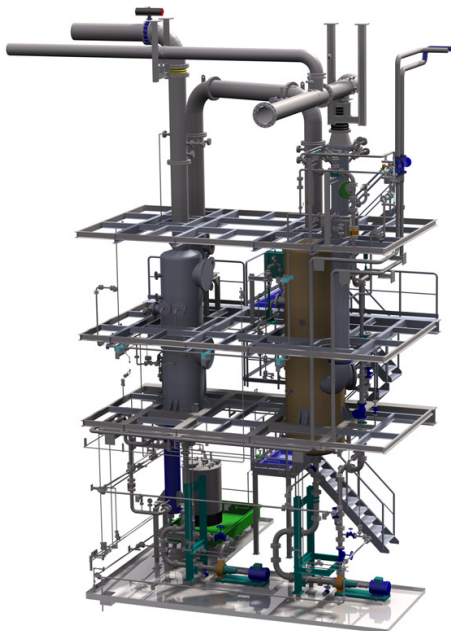

Fig. 4: Flue gas scrubber system



Fig. 5: HEPA filter rack

The flue-gas released from the post combustion chamber is treated in several stages. The temperature of the flue-gas is reduced by quenching in the first step; the quenching water is injected through an air driven nozzle to approx. 200 °C to avoid the formation of dioxins. In the second step the gas temperature is further reduced in two jet scrubbers. These scrubbers remove most of the particles and hazardous chemical compounds from the flue-gas such as HCl.

For the reduction of the off-gas flow after the scrubbers the scrubbing solution of the second scrubber is cooled down a heat exchanger.

The scrubber solution of the scrubbers is periodically refreshed when the concentration of solids, radiation level or salt reaches its limits. The scrubber solution is neutralized and ready for further treatment e.g. in an evaporator.

In the third system the fine filtration of the off-gas leaving the jet scrubber occurs. To prevent condensation in the subsequent HEPA Filter Units the off gas is reheated

above the dew point. Behind the HEPA Filters the off gas is free from radioactive substances.

4. Pressure conditions

The pressure within the components of the incineration process is controlled below ambient pressure a pressure control system. A blower maintains the required pressure conditions during normal operation when high gas flow rates must be processed. During stand-by and weekend operation the system pressure is maintained by an auxiliary blower.

The cleaned off gas can be discharged into a stack. The off gas will be monitored for hazardous chemical emissions and radiation before it is released into the stack.

5. Conclusions

With the compact incineration facility it is possible to reduce the space compared to shaft furnaces by approx. 50% having the same process conditions. Due to the reduced throughput it possible to build facilities for new NPP where the waste volumes are low and no existing waste is present.

Small sized incineration facilities can be prefabricated at vendor's site.

It is possible to switch them off daily for single shift operation mode.

The decontamination factor for non-volatile radionuclides is $>10^6$.

6. Literature

- /1/ Schetter, G.: Cremation technology – Theory and Practice, Handbook on Cremation, FVB-Verlag, 2012.
- /2/ Design and Operation of Radioactive Waste Incineration Facilities
IAEA Safety Series, Safety Series No. 108 IAEA
- /3/ Directive 2000/76/EC of the European Parliament and of the Council
of 4 December 2000 on the Incineration of waste
- /4/ VdS-Verlag 2616:2000-12(01): Kunststoffe, Eigenschaften, Brandverhalten,
Brandgefahren

ENC
2012

EUROPEAN NUCLEAR CONFERENCE



United Kingdom

MANCHESTER
9-12 December 2012

END OF USE: DISMANTLING

TECHNOLOGY AND MANAGEMENT FOR DECOMMISSIONING OF NUCLEAR FACILITIES - A REPORT FROM GERMANY

AHMED STIFI, PATRICK KERN, AKRAMULLAH AMINY,
SASCHA GENTES

*Professorship of Technology and Management for the Decommissioning of Nuclear Facilities (TMRK)-
Institute for Technology and Management in Construction (TMB)
Karlsruhe Institute of Technology (KIT)*

ABSTRACT

Within the German Excellence Initiative Program the Karlsruhe Institute of Technology (KIT) is one of the first Cluster of Excellence which has been established by a merger between the Research Center and the University of Karlsruhe. The world's first professorship for Technology and Management for the Decommissioning of Nuclear Facilities (TMRK) was established in June 2008 at KIT. The TMRK is part of the Institute of Technology and Management in Construction and headed by Prof. Dr.-Ing. Sascha Gentes.

The TMRK's research focuses on the two special fields of technology and management. In the management field, the research team aims to improve and optimize the whole process from procurement, awarding the tender, execution of decommission until the final disposal of radioactive material. One example in this respect is the implementation of the Lean Management Principles to the Decommissioning of Nuclear Facilities.

In the technology field, the research team develops new practical technologies and improves and automates the existing tools, machines and technologies for the decommissioning of nuclear facilities. The main objectives in this area are to minimize the nuclear radiation which endangers the staff working at nuclear facilities and to achieve an environmentally friendly and effective decommissioning process. In addition to the introduction of TMRK institute and its activities this paper will present in general the current research projects from different disciplines like the measurement, ablation and decontamination technique. In the measurement technique aims the project "MAFRO" to develop a comprehensive system for the remote-controlled measurement of radioactive contaminated surfaces while the project "MerEN" aims to develop a monitoring system with integrated measuring sensors for radioactive ferrous and non ferrous scrap metal, in the ablation technique, the goal of both Projects "AMANDA" and later "MANOLA" were to develop an autonomously climbing manipulator for ablation of contaminated surfaces of walls and ceilings. By the decontamination technique the two projects "DePRoV" and "SimViDekont" will be presented within the paper in more details as a new technology for decontamination of tubings. Where the problem of technologically enhanced naturally occurring radioactive material (TENORM) especially in the oil and gas industry is described and current used decontamination methods and its disadvantages from environmental and cost point of view are introduced and compared with the new developed technique which avoiding secondary waste.

1. Introduction

the German history of nuclear energy started in sixty-years with the German Atomic Energy Act "deutsche Atomgesetz AtG 1960" which is the central regulation including all purposes and regulations related to the term "nuclear facilities". Actually exist in Germany different types of nuclear facilities, namely the commercial nuclear power plants, the research reactors and facilities for nuclear supply and disposal. The first constructed nuclear power plant in Germany is "Gundremmingen" nuclear commissioning in 1966, and the last constructed one is "Neckarwestheim 2" nuclear commissioning in 1988. With the privatization

process of the electricity market in Germany the all commercial nuclear power plants has been transferred from state to private sector where the responsibility for the whole facilities including reactors lies by the new owner. In 2000 decided the federal government with the nuclear power plant owners the nuclear consensus which intend to shut down of all German nuclear power plants till 2022 and no more new power plant can be built. In 2010 the new federal government decided to extend the operating time of the 17 in operation power plants to 8 years for power plants built before 1980 and to 14 years for the power plants built after 1980. Consideration the new decision the shutdown of the power plant “Neckarwestheim 2” will be in 2036 instead of 2022. Only four days after catastrophe of Fukushima in Japan on 11th of March informed the same federal government the 3-month moratorium. As a result of this moratorium decided the federal government on 6th of June to shut down the seven oldest nuclear power plants and to go back to the 2022 phase out nuclear power policy.

This makes it quite clear that in the next 10 years in general 17 commercial nuclear power plants in Germany need to be decommissioned. Techniques for decontaminating and dismantling nuclear facilities are available and the current situation is thus that much has already been done but much remains to be done [1]. In this sense, describe the professorship of technology and management for decommissioning of nuclear facilities (TMRK) itself as an education and research institute with the aims of establishing a major study course focusing on decommissioning of nuclear facilities and create a competence team in this field, improve the current technologies and develop a new one.

As mentioned above the scope of work of TMRK includes a several disciplines and the following introduced research projects are only some examples of its activities in field of dismantling and decontamination technology.

2. Examples from shaving and ablation Technology

Decontamination is defined as the removal of contamination from surfaces of structures or equipment by washing, heating, chemical or electrochemical action, mechanical cleaning, or other technique. When decontaminating concrete surfaces, mainly mechanical scarifying techniques such as needle scaling, scabbling or shaving/milling are used [2]. The milling process has many advantages like, high performance, treatment depth can millimeter exact set up, low to middle noise emission and in the first instance the minimization of the waste production. The main disadvantage of the milling process till now is that its use should be with a big arrangement like a portal scaffolding system. Both cases require a short-term stay of staff in the work field.

2.1. Project-AMANDA: Autonomous Manipulator for Decontamination Assignments

The innovative research project AMANDA- in 2008 innovation prize awarded from state Rhineland-Palatinate has been developed as a solution for decontamination of large concrete surfaces either for wall or for ceiling surfaces. The remote-controlled system is a climbing manipulator integrated with milling unit. The suction plates (vacuum system) hold safely manipulator to the treated component. The performance of AMANDA is between 6 to 8 m²/h with controlled milling depth of 3 to 4 mm [3]. The system needs only one remote-operator.

2.2. Project-MANOLA: Manipulator Operated Laser Ablation

TMRK does not aim only to improve or develop a new process; rather more the TMRK aims to continue improvement of the new developed systems. The research project MANOLA as a further development step of AMANDA, which already shown the operability of integration between a decontamination process and the stand-alone support system. The new system is similar to AMANDA in term of support system, manipulator moving and holding however

within MANOLA the integrated unit for decontamination of concrete surfaces is a laser unit instead of milling unit.

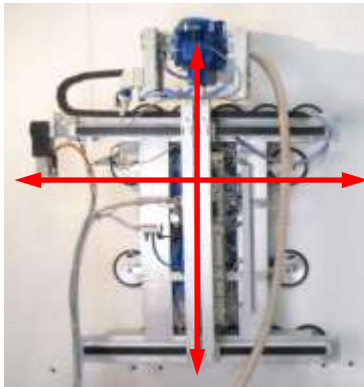

Fig 1. AMANDA

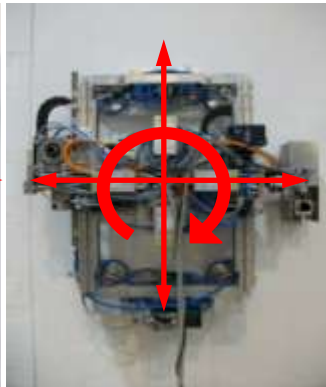

Fig 2. MANOLA



Fig 3. Trolley System

3. Examples from Measurement Technology

The effort of decommissioning process is dependent on what is known about the degree of contamination which is related to the type of radiation and its energy. These can be measured to ensure from when till when the process should be adapted. The TMRK researchers aim to integrate the measurement dimension in the decontamination systems to achieve a high degree of autonomy in one system.

3.1. Project-MAFRO: Manipulator Operated release Measurement of Surface

The research Project MAFRO is Based on the results of MANOLA project and it is a joint project between the Institute for Process Control and Robotics (IPR) and TMRK. MAFRO is already started end of 2011. The aim of the project is to have one system which includes the three main steps of decontamination of surface, namely measurement of radioactivity of component (Pre-Measurement process), decontamination process and the release measurement (Post-Measurement Process) however in Germany the release measurement values are regulated after Radiation Protection Ordinance §29 StrlSchV. Currently such whole system for measurement-decontamination-release is not existing. The target system exists from three main components, namely the manipulator as a support system with transport system (trolley system), the laser device as decontamination tools, and a detector head which is in development phase. The detector head should be implemented to the manipulator as a measurement tool for the radioactivity and integrated with scanner to generate an environment model which will be the basic for autonomous, collision-free navigation and accurate the documentation of the release measurement process. With MAFRO the whole process could be teleported from a safe distance.

3.2. Project-MerEN: Monitoring System with integrated Measuring Sensors for Radioactive ferrous and non-ferrous Scrap Metal

The research project MerEN deals with radiation sources, which passed on without permission or get lost, which are called "orphan sources". The orphan sources may be discovered by individuals who are unaware of its risks. Radioactive sources are regularly found in scrap yards and facilities of metal processing and represent a threat to the people and the environment thus a radiological monitoring of these materials is becoming increasingly important.

As part of the research project MerEN, a monitoring system with integrated measuring sensors for radioactive ferrous and non-ferrous scrap metal is to be developed. The operator of the scrap-metal sites have the opportunity to detect radioactively contaminated material at early stage - before a possible radioactive source is crushed and mixed with non-radioactive material. After detection of a radioactive source, the user receives an instruction on how to proceed. This leads to an increasing in product purity and in occupational health and safety of staff and environment.

4. Example from Decontamination of Tubings

The TMRK doesn't limit its research only to the reactor facilities; the focus is always there, where radioactive contamination exists. The decontamination of tubings from the petrol and gas industry is an example.

4.1. Project-DePRoV: New Process for Decontamination of Tubings by means of Vibration Technology

Technologically enhanced naturally occurring radioactive material (TENORM) is found in the scales of tubings and it should be removed. Currently used decontamination methods in this field are based on water jet- and abrasive blasting technology which produce a high amount of secondary waste [4]. The main goal of DePRoV was to develop a new decontamination technology avoiding secondary waste. The characterization of the scales has shown that the scales are hard and brittle and can be removed by applying a defined mechanical force to spall it. The new decontamination method is based on vibration as one kind of mechanical process. A test stand has been built to investigate the decontamination process; meanwhile to enable the research in equal conditions, different types of deposits have been formed inside the pipes. The next steps was the evaluation of the process describing relevant factors of influence, namely the hardness and thickness of the deposits, tool's geometry, distance between the tool and the inner wall of the pipe, the rotation parameters (frequency and mass of the imbalance of the vibrator) and feed rate.

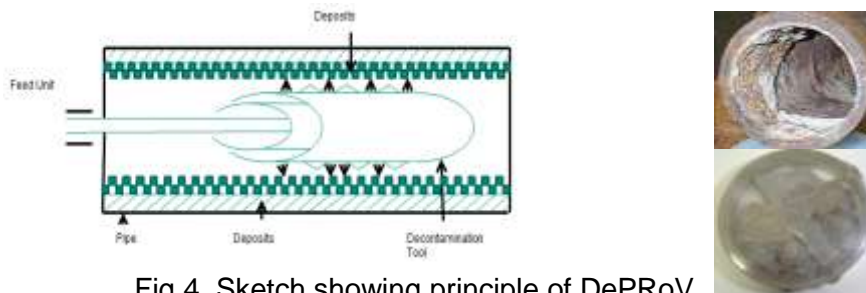

Fig 4. Sketch showing principle of DePRoV
With removed scales

4.2. Project-SimViDeKont: Create a simulation model to qualify the new vibration technology for Decontamination of Tubings

The SimViDeKont research project is cooperation between institute for Information management in Engineering (IMI) and TMRK. It is further development of DePRoV Project and aims to create a simulation model to examine and to qualify the new vibration method for decontamination of tubings. This should be validated through comparisons with test results in physical prototypes.

As mentioned above the results of DePRoV research project confirms the fundamental function of decontamination of tubings by means of vibration process, however, the closure of an exact investigation was not possible. To carry out this within a suitable time frame and

without any radiation hazard, new attempts have been investigated. Modern simulation technologies enable researchers to investigate complicated processes and procedures virtually as well as to examine it's efficiently, adaptably and repeatable in an ecologically and environmentally manner.

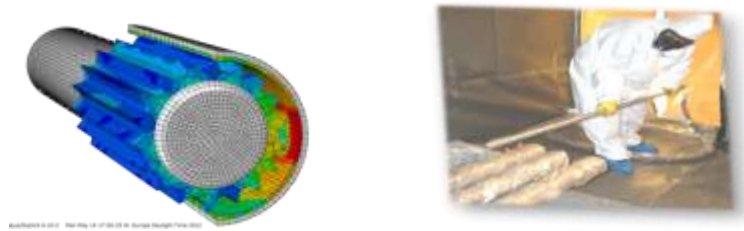

Fig5: Simulation of Vibration Process “SimViDekont Project”

5. Conclusion

The authors of this report aimed to introduce briefly the current situation in Germany and in the same time to clarify that the end use of nuclear power in Germany is not mean the end of research in this field, with this end a new start has been begun. The TMRK is one example in this regard.

With its two main policies, namely “Continual Improvement” and “Sharing-Knowledge”, the TMRK invite all interested parties from the education and research institutions, industries and stockholders to cooperate in this field aiming to achieve sustainability in term of technology and management for Decommissioning of nuclear facilities.

6. References

- [1] The OECD Nuclear Energy Agency (NEA); The Decommissioning and Dismantling of Nuclear Facilities, Status, Approaches, Challenges; (Pages 8 and 15); OCED 2002.
- [2] European Commission-Coordination Network on Decommissioning (EC-CND); Dismantling Techniques, Decontamination Techniques, Dissemination of Best Practice, Experience and Know-how; (Pages 9, 33 and 34); Final Report 2009.
- [3] J. Bremmer; S. Gentes; R. Littwin; A. Hurtado; W. Lippmann; Innovative surface decontamination using a manipulator-deployed laser system; Annual meeting on Nuclear Technology 2010.
- [4] A. Aminy; S. Gentes; F. Ambos; Decontamination of Tubings using Vibration Technology; American Nuclear Society Conference in Idaho 2010.

WESTINGHOUSE WASTE SIMULATION AND OPTIMIZATION SOFTWARE TOOL

J. Boucau

*Global D&D and Waste Management, Westinghouse Electric Company
43, Rue de l'Industrie, B-1430 Nivelles - Belgium*

Dr. J. Aign*, K. Mennicken**

*Global D&D and Waste Management, Westinghouse Electric Company
* 6, Tarpenring, D-22419 Hamburg - Germany / ** 44, Dudenstraße, D-68167 Mannheim - Germany*

ABSTRACT

In radioactive waste management tasks, different kinds of waste with different volumes and properties have to be treated. Finding a technically and commercially optimized waste treatment concept is a difficult and time consuming process.

The Westinghouse waste simulation and optimization software is an important tool to study the total life cycle cost of any waste management facility. It enables the user to optimize the number of treatment systems, determine the design capacity for onsite storage facilities and to identify the most cost-effective treatment by maintaining optimal treatment paths. Further, the user of the waste simulation and optimization software is able to simulate storage and process buildings and is able to identify bottlenecks in the overall waste management design before starting detailed planning activities.

In combination with integrated waste management solutions and proven waste treatment equipments, the waste simulation and optimization software provides reliable qualitative results that lead to an effective planning and minimizes the project planning risk of any waste management activity.

1. Introduction

During operation and D&D of a nuclear power plant, different levels of radioactive waste are generated. This waste is subject to safe and professional treatment to avoid environmental impact. Further, it is of major interest to decontaminate radioactive waste to recycle the material or to release it into the conventional waste stream. All other waste types must be conditioned for intermediate or final storage.

Waste treatment facilities, equipped with the respective technology to treat, decontaminate, condition and store primary, secondary and final waste products and packages are required to complete this task.

To plan, build and operate such facilities in a technologically and economic viable manner, intensive preparation and planning has to be conducted.

The Westinghouse waste simulation and optimization software tool supports these preparations and planning essentially.

2. Simulation and Optimization

The Westinghouse waste simulation and optimization software tool is a Monte Carlo based graphical program that carries out a dynamic, probabilistic simulation with a user-friendly interface. With these properties, the software is capable to consider various variables in parallel during waste management scenario simulation and optimization, such as storage capacities, equipment space requirements, equipment performance factors, volume reduction factors, different operating cost and disposal cost factors, variations in waste feed

composition and various waste treatment methods in highly integrated waste management treatment facilities.

The term "dynamic" means for the waste simulation and optimization software tool, that not only chronologically limited parameters or values (e.g. volume flow) spread over the total timeline can be considered. It is possible to vary the parameters within discrete time frames and to add statistical uncertainties to all relevant parameters, e.g. to consider fluctuations in the input waste flow.

Starting with the identification of the waste streams and assessment of various treatment concepts, the main input to the simulation and optimization software is an integrated waste treatment concept that covers all relevant waste streams. The basis of the simulation model shall be built up with information and guidance parameters to achieve more accurate final results. After implementing suitable equipment data into the final model, process requirements and waste treatment data are fed into the simulation to finally generate primary simulation results. A sensitivity analysis of automated optimization features of the software generates the lowest possible lifecycle cost for the simulated waste stream. Also other target values might be subject to the automated optimization.

Usually, a simulation model is built according the following steps:

- scope definition and requested result complexity
- identification of waste streams and main parameters, e.g. total volume per stream, waste volume flow in defined discrete time intervals, specific activity, specific/required/preferred treatment method, etc.
- compilation of known limits and assumptions
- identification of adequate treatment methods and technologies
- compilation in an integrated waste treatment concept and preparation of flow diagrams
- definition of required limiting parameters, e.g. limited building dimensions, limited activity inventory, chronological/schedule limits, exclusion of technologies, etc.
- compilation of required process- and technology parameters (e.g. from existing equipment library or compilation of library)
- preparation of specification and functional requirements
- adjustment of user interface
- programming of simulation model and user interface according specification and functional requirements
- test runs, customer review, optional adjustment
- final validation and result generation
- result report

The above mentioned steps are tentative approaches and must be discussed with each customer according the specific scope and requirements. The depth of parameter details varies strongly with the scope of simulation.

2.1. Parameters and specification

As described above, the preparation of a detailed specification and functional requirements with clearly defined definitions and scope is of ultimate importance. The planning phase that leads to the specification is usually done in close cooperation with the customer to define the objective and the required parameters and data. Obviously, this is the only viable way to program the simulation to create realistic and credible results that supports the customer in finding a final decision. The specification includes all important objectives, selected treatment technologies and clearly defined parameter definitions that are to be filled with data. It also includes the necessary information to create the user interface and all required analysis functions. Thus, the specification shall be the basis for all programming work that leads to the simulation model.

2.2. Simulation model

The simulation is programmed according the specification and the functional requirements. Among the defined and required properties to create results, the simulation model includes all data and parameters that can be adjusted to perform a sensitivity analysis and to simulate different scenarios, e.g. modifiable equipment parameter, operation cost, storage capacities, etc. The model is preferably built with simulation modules, each representing a single waste treatment equipment. New modules and simulation parameters can be added to the modules, as specified by the customer.

2.3. User interface

The graphical user interface is created according to the specification and the functional requirements. The variation of input data, other parameters and eventually the visualization of the results are realized with the graphical user interface. Thus, sensitivity analyses by varying the equipment parameters or even exchange of equipment to simulate different treatment methods of a waste stream can be done to analyze the effects on the facility performance or the total life cycle cost. The user interface can be organized in different, protected user levels. The following figures show examples of a possible user interface and results.

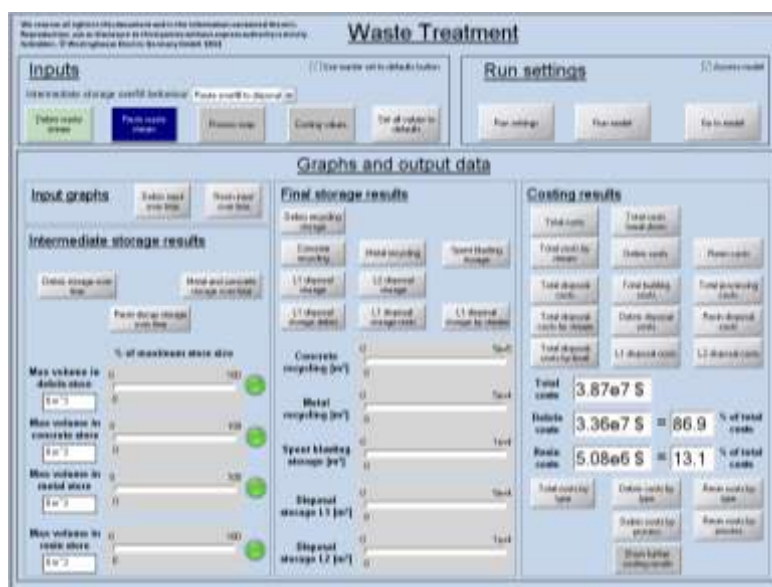

Fig 1. Example of a graphical user interface, level 1

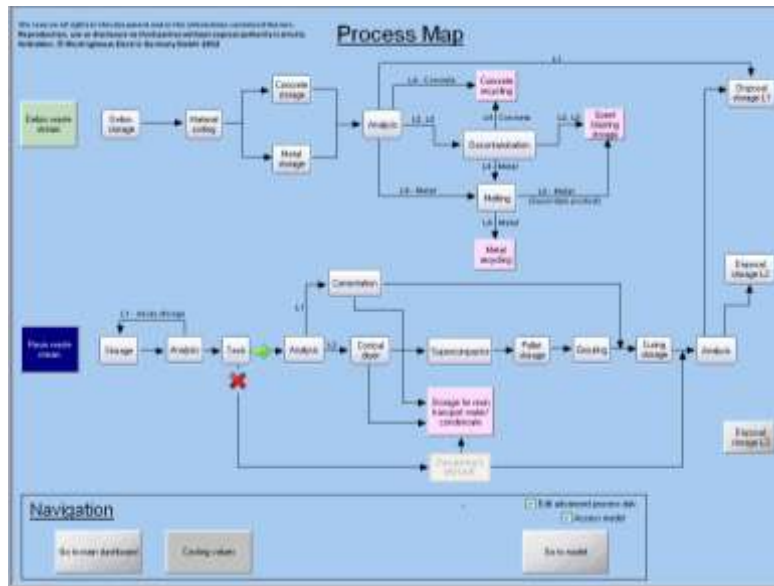

Fig 2. Example of a graphical user interface, level 2 (block flow diagram)

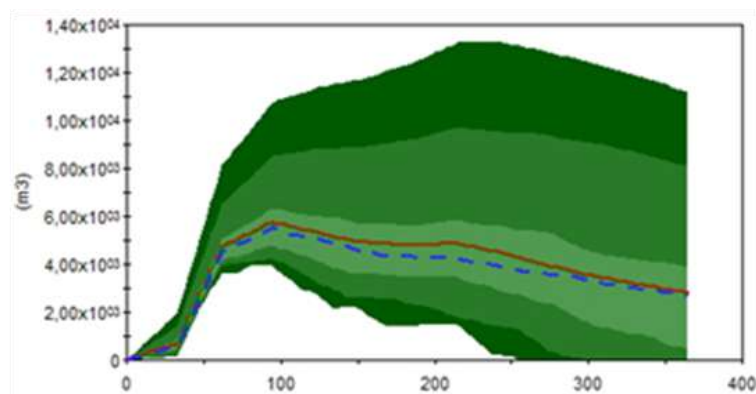

Fig 3. Example of a result graph:
facility throughput over time with fluctuation probability (green shades),
median (blue) and mean (red)

2.4. Sensitivity analysis and optimization

The simulation model is used to perform sensitivity analyses by altering specific parameters. It is possible to alter operating data of the equipment, as well as boundary conditions or other limiting factors, as defined in the specification. The results and scenarios are saved separately and are subject for further analysis.

The optimization function of the software tool is an automated calculation based on the given simulation model to minimize or maximize the value of a selected parameter by altering other simulation parameters, but maintaining all given boundary conditions (e.g. given waste volume flows, maximum building dimensions, fluctuations and uncertainties). Thus, minimum life cycle cost of the overall facility or minimum space requirement for storage can be calculated.

The results and scenarios created by sensitivity analyses and optimizations are saved separately and can be compared to draw conclusions for further simulation or final decisions. The following figure shows an example of a possible result and scenario comparison.



Fig 4. Example of result and scenario comparison

3. Conclusion

The Westinghouse waste simulation and optimization software tool helps to identify the process setup for the lowest life cycle cost for any waste management facility that treats radioactive waste from operating NPP, D&D activities or legacy waste. Detailed cost analysis and cost driver identification, as well as sensitivity analyses in a complex environment and process bottleneck identification is possible. Using the simulation enables virtual trial and error without risk to identify the best applicable treatment technology. In summary, the Westinghouse waste simulation and optimization software tool supports the customer with reliable data for a mature decision.

SAFETY ASPECTS OF BELGONUCLÉAIRE DESSEL MOX PLANT DECOMMISSIONING IN BELGIUM: EXPERIENCE FROM A GERMAN MOX-FACILITY AND RECENT IMPROVEMENTS APPLIED TO THE BELGIAN PROJECT

R. BAUMANN

*Siemens AG, Energy Sector
Seligenstädter Str. 100, D 63791 Karlstein a. Main, Germany*

J.M. CUCHET

*Tractebel Engineering
Avenue Ariane 7, B 1200 Brussels, Belgium*

DR. E.-D. KOHLGARTH

*TÜV NORD Nuclear
Am TÜV 1, D 30519 Hannover, Germany*

M. VANDORPE

*Tecnubel
Zandbergen 1, B 2480 Dessel, Belgium*

ABSTRACT

Belgonucleaire (BN) has operated the Dessel MOX plant from the mid-80's at an industrial scale. Over 35.000 kg plutonium were processed in LWR fuel. The operation of the plant is finished and a license for decommissioning was granted in March 2008. TÜV NORD EnSys Hannover GmbH & Co. KG (TÜV NORD EnSys, also called TNE hereafter) advised BN in the field of decommissioning and assisted BN in special aspects of improvement of the practised techniques (qualification of a Pu-measurement equipment) and in the assessment of some special issues (call for bid files).

The decommissioning work started in March 2009. The planning of the decommissioning considered the experience gained in the dismantling of the Siemens MOX facility in Hanau, Germany, this facility was decommissioned during the years 2001 to 2006. There, TNE was involved in the quality control of the produced waste packages on behalf of the German Federal Office for Radiation Protection (BfS) as well as for the decommissioning on behalf of the German supervisory authority of the federal state of Hesse.

As a major part of the BN project, about 170 glove boxes are foreseen for dismantling and for further treatment as radioactive waste. Siemens used cold and dry cutting techniques in a special tent or in a dismantling glove box for the dismantling of 235 glove boxes. BN uses the same cold and dry cutting techniques in a disposable tent as Siemens did. All waste items are cut and packed into drums. The plutonium of the drums is monitored by a Slab counter during the loading of the drums. For the measurement of their plutonium content BN uses the same devices as Siemens did. The content of the whole drum is measured by means of a monitor especially designed for 200-l drums. For the measurement of the fissile material contamination of larger items serves another equipment also used by Siemens .

Selecting proven technologies for the glove box dismantling is a major concern for safety, radiation protection and also for cost control. Of course, due to the experience gained during the Siemens decommissioning project, the dismantling techniques have been improved to enhance safety. For example, for an increase of radiation protection a special γ -shielding for the tents was designed; cutting techniques and handling systems were optimized to reduce the exposure of the operators.

1. Situation of the BN MOX-Plant

The BN production plant was commissioned in the early 1970's. The industrial stage was reached in the mid-1980's.

The Dessel MOX-plant is arranged in an intricate network of interconnected glove-boxes (GB) with volumes ranging from 0.5 m³ up to 15 m³. Figure 1 shows a typical arrangement of glove-boxes. In 2005 BN came to the decision to terminate the production; BN prepared the required application file to perform the decommissioning; in 2008 the respective license was granted by the Belgian authorities. A request for proposal, reviewed by TÜV NORD En-Sys Hannover, was sent to possible tenderers for performing the decommissioning. By the end of 2008 the decision on the organization of the whole project was fixed. The dismantling work started in March 2009.



2. Decommissioning strategy

All reusable fissile materials have been removed from the plant. A cleaning of glove-boxes and internal equipment took place to reduce the contamination risk and the exposure of the personnel.

Except for some particular cases, BN decided to perform the glove-box disassembly in special disassembling tents, similar to those, which were used during the decommissioning of the Siemens-MOX-plant in Hanau, Germany [5, 6]. These dismantling tents are made of polyester fabric sheets mounted on an aluminium frame. They are designed and fabricated in cooperation with a specialized supplier. Each tent foil can only be used once and has to be sized and installed individually for each glove box to be dismantled (Fig. 2). These "dismantling glove boxes" and tents are connected to the glove box exhaust air system and serve as the first alpha barrier during disassembly work (see also [2]). This original technique used by Siemens for 70% of the glove boxes present in its plant was approved by RWTÜV, now TÜV NORD EnSys.

During the dismantling of the glove boxes, the interior equipment ("internals") and the glove box itself are cut into pieces of various sizes using nibbling and sawing techniques. The pieces are transferred directly into 200-l drums using a special lifting and tipping cart that prevents the spread of contamination (see Figure 2).



Figure 2: Typical dismantling tent with docking station

3. Decommissioning Process

The steps of the decommissioning process are summarized in the following list:

- Removal of fissile material
- Partial disassembly of non-contaminated equipment
- Preparation of work areas for tent installation
- Installation of additional equipment for waste management/Pu-measurement (e.g. DISPIM[®] or slab counter)
- Process glove-box dismantling in tent:
 - Empty the glove-box of most of its internals (*in situ*),
 - Isolate and separate GB's,
 - Transfer GB in tailor-made tent or mount tent around GB,
 - GB dismantling and waste processing under disposable glove-tent,
- Installation of a temporary building ventilation
- Room decontamination
- Removal of remaining equipment
- Dismantling of common utilities
- Free release of the building and the site

4. Benefits of the tent dismantling technology

BN considered the disposable tent and the use of a cold and dry cutting technique with sawing and nibbling as the best available techniques for the following reasons: the technique was first used by Siemens, Hanau, and was accepted by the local authorities. An assessment was made by RWTÜV, now TÜV NORD EnSys. This allowed BN to elaborate and present a decommissioning plan supported by experience from a similar plant to the Belgian authorities. The implementation of the tent technology also allows parallel processing in different workshops.

Plasma cutting techniques and abrasive grinding were not selected because of an increase of fire risk and the risk of contamination spread ([5], [6], [7]).

5. Improvements of the tent technology

One of the main concerns of BN is to limit the personnel's external radiation exposure. The target is to remain below the limits defined in the State Regulations and is according to the ALARA principle. The main exposure is resulting from γ -radiation generated by Am-241 and neutron irradiation originating from (α ,n) reactions.

For this reason, BN improved the SIEMENS approach by developing reusable modular shielding panels to be placed between the tent and the workers. The panel is attached to the external tent supporting structure (see Figure 3). Before starting a dismantling operation the need for such additional shielding is checked.



Figure 3: Modular shielding panels

After cutting the glove-box, a water-based varnish to fix the contamination at the inner surface of the tent improves the safety of the tent fold-down operation. BN has to shred the tent and put the pieces into drums [7], whereas Siemens was allowed to put the whole tent into one container [4].

Other considerable improvements have been introduced regarding dry and cold cutting tools: e.g. use of bandsaws to cut the glove box structure, use of cordless portable saws to minimize electrical risks (no cables).

6. Measurement techniques

Depending on the size of the respective items various systems are used for the determination of the amount of fissile material [2]. The determination of the plutonium content is based on the measurement of the coincident neutrons from the spontaneous fission of plutonium combined with the determination of the isotopic composition by high-resolution gamma spectrometry.

The inorganic waste, consisting of fragmented metallic components (internals and parts of glove-boxes), and the organic waste, consisting e.g. of panels (Polymethyl Methacrylate), glove ports and gloves, are transferred into 200 litre waste drums directly from the disassembly process.

While the drums are filled, additional checks are carried out for compliance with the maximum allowable Pu content (59 g Pu/drum) using a slab counter. The filled drums are scanned by a drum detection system specially designed for 200-l drums. This drum measurement system called WDM 200 was first used by Siemens Hanau and was qualified by experts of TÜV NORD EnSys together with the German Federal Office of Radiation Protection (BfS) [3]. The WDM 200 is now qualified by the Belgian authorities.

In order to plan the further work sequences, radiation protection measures and waste management, the remaining fissile material residue inside GBs has to be determined. For this purpose a special portable measuring device - the Decommissioning In-Situ Plutonium Inventory Monitor (DISPIM[®]) - was developed by BNFL. Hot spots within a GB can be detected easily; the whole Pu-Content of a glove box can be determined as well. This system can be placed around the components individually [3].



The DISPIM[®] was first used by Siemens, qualified on behalf of the BfS by TÜV NORD EnSys, and is used by BN. TÜV NORD EnSys experts supported BN in the necessary (re)qualification of the system by the Belgian authorities.

An example of a typical arrangement of the DISPIM[®] assemblies around a glove box is given in Figure 4. The glove-box is at the centre of the mobile device; the blue assemblies for neutron counting are placed around the glove box in defined positions.

by

7. Safety strategy

Actions have been undertaken by BN on 3 levels:

- Level 1: selection of the contractors :
only specialized and qualified companies were considered;
- Level 2: qualification and training of the operators
 - Training center;
 - 'Mentorship' principle for each new operator;
 - Continuous evaluation;
- Level 3: work organization and decommissioning

For the training of contractors, a training center was developed (see Figure 5); its main functions and objectives are the following:

- Simulation of activities in cold conditions
(*Training in mockups: 4 gloveboxes and 2 tents*)
- Qualification of decommissioning techniques (e.g. for handling and decommissioning of ball mills, sinter furnaces, ...)



Figure 5: Training in cold conditions for working in glove boxes and in tents, at BN

8. Conclusion

Prior to the decision to terminate the MOX production, BN performed a survey of existing decommissioning techniques used for glove boxes. They were compared and evaluated mainly for their industrial safety and health performance. BN selected the disposable tent technology with cold and dry cutting processes as the main dismantling option. BN further improved the techniques, already used during the decommissioning of the Siemens-plant in Hanau, Germany.

Additional reusable radiation shields were designed to improve the workers protection without impairing their handling capability. A significant effort was made with regard to nuclear safety.

TÜV NORD EnSys Hannover assisted BN in special aspects of improvement of the practised techniques, in (re)qualification of measurement devices and in the assessment of some special issues (call for bid files).

The nuclear services company Tecnubel is one of the contractors who carry out the dismantling operations at BN and is also in charge of the radiological measurements.

BN contracted Tractebel Engineering for engineering assistance.

Some figures about the progress of the work are given in Table 1:

	Number of GB's (#)	Begin of Dismantling	End of Dismantling	Progress (%)	Safety aspects
Siemens (Hanau)	165	2001/06	2006/09	100 % (completed)	no incidents with nuclear impact
Belgonucleaire (Dessel)	170	2009/03	n.a.	75 % (on going)	no incidents with nuclear impact

Table 1: Representative figures of the German and Belgian projects

REFERENCES

- [1] R. Baumann, P. Faber: "Dismantling Techniques for Plutonium-Contaminated Glove Boxes: Experience from First Year of Decommissioning", 6th International Symposium of Radioactive & Decommissioning Waste, Kontec 2003, Berlin, Germany, March 2003
- [2] H. Rupaar, R. Baumann, P. Faber, M. Ruhbaum, H. Schmitt: "Decommissioning of four German fuel cycle facilities"; Waste Management 2000, Tucson, ANS-meeting report, Radwaste Solutions Vol. 7, No. 3, May/June 2000
- [3] G. Grondey, E. Kohlgarth, I. Hanel: "Decommissioning of a MOX facility in Germany: Applied techniques for minimization and optimization of loading containers with nuclear grade waste for final repository"; Proceedings, 9th International Conference on Environmental Remediation and Radioactive Waste Management (ICEM), September 21-25, 2003, Oxford, England
- [4] E. Kohlgarth, R. Baumann; S. Steyer: "Decommission of fuel Cycle facilities in Germany: Applied techniques and quality assurance measurements"; Proceedings, 10th International Conference on Environmental Remediation and Radioactive Waste Management (ICEM), September 4-8, 2005, Glasgow, Scotland
- [5] A. Vandergheynst; JM Cuchet: "Strategy For Decommissioning of Glove-Boxes In the BELGONUCLEAIRE Dessel Mox Fuel Fabrication Plant"; Proceedings, 11th International Conference on Environmental Remediation and Radioactive Waste Management, (ICEM), September 2-6, 2007, Bruges, Belgium
- [6] A. Vandergheynst; JM Cuchet: "An evolutionary approach for the decommissioning of the glove boxes in the BELGONUCLEAIRE Dessel plant"; Proceedings, SFEN International Conference; September 28 - October 2, 2008, Avignon, France
- [7] JM Cuchet; H. Libon; C. Verheyen,; J. Bily; J. Custers; R. Walthéry: "Decommissioning The Belgonucleaire Dessel Mox Plant: Presentation of The Project and Situation on 30/06/2011"; Proceedings, 14th International Conference on Environmental Remediation and Radioactive Waste Management, (ICEM), September 25-29, 2011, Reims, France

NPP DECOMMISSIONING AND MANAGEMENT OF RADIOACTIVE WASTE : THE EDF EXPERIENCE

E. DESROCHES, S. BEGUIN
EDF, Nuclear Fuel Division
1 place Pleyel, 93282 Saint-Denis - France

P. BERNET
EDF, CIDEN
154 avenue Thiers, 69006 Lyon - France

ABSTRACT

As leading nuclear power plant operator in the world, EDF is among the largest radioactive waste producers. EDF is also engaged in a decommissioning programme of nine shut-down reactors. EDF operates in France, which benefits from a strong framework of law, regulation and a requirement for transparency. How EDF, as a responsible nuclear operator, meets all its obligations in both waste management and decommissioning is the subject here. With that situation in mind, EDF has developed global waste management strategies, centralised industrial-scale organisations and technical expertise. On a European level, the increased awareness of the issue of radioactive waste, combined with the potential of early decommissioning of power plants in countries that have decided to phase out nuclear power, will lead certain countries to anticipate the planning of the implementation of solutions for their waste. EDF is able to provide them with recognised expertise on waste management solutions.

Introduction

As leading nuclear power plant operator in the world, EDF is among the largest radioactive waste producers. EDF is also engaged in a decommissioning programme of nine shut-down reactors. EDF operates in France, which benefits from a strong framework of law, regulation and a requirement for transparency. How EDF, as a responsible nuclear operator, meets all its obligations in both waste management and decommissioning is the subject here. With that situation in mind, EDF has developed global waste management strategies, centralised industrial-scale organisations and technical expertise.

The Decommissioning Programme Conducted by EDF

In France, nine nuclear power reactors, definitively shutdown between 1973 for the oldest, and 1997 for the most recent, are currently being decommissioned under EDF responsibility. These nine reactors are from four different technologies:

- one Heavy Water Reactor – Brennilis (70 MW)
- one Pressurized Water Reactor – Chooz A (300 MW)
- six Natural Uranium Gas Graphite Reactors – Chinon A1 (70 MW), Chinon A2 (200 MW), Chinon A3 (480 MW), Saint Laurent A1 (480 MW), Saint Laurent A2 (515 MW), Bugey 1 (540 MW)
- one Fast Breeder Reactor - Creys-Malville (1240 MW).

The decommissioning programme also includes building and operation for 50 years of the waste conditioning and interim storage facility for long-lived ILW (ICEDA facility), decommissioning of fuel interim storage facility at Creys-Malville (APEC facility), and decommissioning of Saint Laurent silos, used for the temporary storage of graphite sleeves.

Initiated in the 1990s, the programme has been reviewed in 2001 adopting the strategy aiming to perform decommissioning in the shortest possible time, then recommended by French Nuclear safety Authority and IAEA, now required according to the 7th February 2012 ministerial decree.

A unit comprising 550 engineers based in Lyon (Centre d'Ingénierie Déconstruction et ENvironnement, CIDEN) has been created by EDF in 2001, to manage the whole decommissioning programme, as EDF decided at that time to go into complete decommissioning of these nine reactors. CIDEN is in charge of the definition of the technical program (schedules, choice of technical solutions), the elaboration of the commercial strategy and the coordination and the control of all works implemented on sites, as EDF is the licence-holder company and completely responsible for decommissioning sites.

By the end of 2011, global decommissioning progress rate was 30 %, with rates around 50 % for Chooz A (PWR), Creys-Malville (FBR) and Brennilis (HWR). Some major steps have been successfully achieved :

- Industrial start up in 2010 of the "Super-Phenix" sodium elimination process in Creys-Malville : the industrial treatment target rates are today achieved ; more than 50% of sodium (3 150 tons among 5 950 tons) has already been treated. The end of the treatment operation is scheduled in 2014 and will allow significant decrease in operating charges and constraints on that site.
- Starting of the principal primary circuit decommissioning in Chooz A : as of today the four steam generators (SGs) have been removed and are undergoing decontamination, first shipping of these SGs to the Very Low Level Waste disposal being scheduled before the end of 2012.
- Complete elimination of adjoining nuclear buildings at Brennilis and Chooz A, using a complete process approved by the Nuclear Safety Authority.

In addition to these achievements, numerous engineering studies have been carried out, to prepare operations to come. Chooz A reactor vessel decommissioning detailed studies are well advanced, operation will start in 2014. In Brennilis, reactor block decommissioning studies are progressing. In Creys, the step following sodium treatment will be the reactor water filling scheduled in 2015, to perform the vessel decommissioning next. In addition, the gas graphite reactor under-water decommissioning scenario, is today being studied in detail on the basis of Fort Saint Vrain feedback (USA).

With regard to the radioactive waste management routes as described further in the paper, 26 000 tons of very low level waste (VLLW) and short-lived low and intermediate level waste (LILW) among the 182 000 tons forecasted for total first generation reactors decommissioning programme have already been sent to these disposal sites (i.e. 14 %). Long-lived Intermediate Level Waste will be temporarily stored at ICEDA, which construction is on the Bugey site and is currently stopped since the building permit cancellation. That interim storage will allow for the future timing and scheduling of the Andra deep geological repository, for which commissioning is forecast by 2025 (500 tons according to the current program).

The 17 000 tons of graphite from the six gas graphite reactors have no waste route for the present time, as the Andra (the National Radioactive Waste Agency) research process for a disposal site is suspended, in spite of the 2006 waste act, which required that such a facility has to be in operation by 2013. The Bugey 1 reactor (integrated technology) has been selected as first in line for the six Gas Graphite Reactor technology programme. EDF is

planning to start graphite stack removal by the year 2022 provided that the waste route is available at that date.

Radioactive Waste Management : EDF Responsibilities and Strategy

As leading nuclear power plant operator in the world, EDF is also among the largest radioactive waste producers. The fleet of 58 pressurised water reactors in service in France generates every year 10 000 to 15 000 m³ of short-lived waste (technological, maintenance and process waste). 1 200 tons of spent nuclear fuel are produced annually and 1 050 tons are reprocessed at Areva's La Hague facility, producing around 150 m³ of high level waste (HLW) and 200 m³ of intermediate level waste (ILW) per year. The decommissioning programme of EDF comprises 9 shut-down reactors, planned through to the 2030s and that will generate a total of 180 000 tons of radioactive waste, mainly very low level waste (VLLW) and low level waste (LLW).

The role of EDF in radioactive waste management is clearly defined in the French law through the 2006 waste act, which was reinforced in 2011 with the Nuclear Waste European Directive. These two legal texts clearly place the full and entire responsibility on the industrial operators whose activities are the source of the wastes. Thus, EDF is responsible for the radioactive wastes it has generated, with no possibility to transfer the responsibility and with no limit in time : on the one hand, EDF is responsible for assuring or making sure that they are properly managed ; on the other hand EDF has to secure the funding for the long term management of its wastes.

From the very outset of France's nuclear power programme, EDF developed industrial-scale management of the radioactive waste produced by operation and maintenance of its 58 pressurised water reactors in service. This management process has constantly progressed thanks to feedback and experience and in line with changes in the regulations and available technologies. This process is also now implemented for the management of waste generated by the decommissioning operations described above. It ensures the exposure, at every stage from production to final disposal, is controlled to minimise the risk. The strategy adopted by EDF for sustainable management of its radioactive waste is as follows :

- limit the waste quantities at the generation stage, by recycling or treatment ;
- sort out the radioactive waste by nature and activity level in order to facilitate the treatment, conditioning and disposal ;
- package the radioactive waste as soon as it is generated ;
- limit the use of storage and send to disposal as soon as reasonably practicable.

Short-lived Waste Produced by NPP During Operation or Decommissioning : Complete and Safe Management Routes from Generation to Disposal are in Current Operation

Continuous improvements in NPP design, fuel management and NPP operation have helped to divide the amount of short-lived waste by a factor of 4 over the past 25 years, for a given electric output : 51 m³/TWh in the mid 1980s vs. 13 m³/TWh in 2009. Compaction equipment for LLW has been widely installed on nuclear stations. Beyond the improvement of waste management technologies, the reduction in waste production was also obtained through the professional and responsible behaviour of those involved. One can give as notable examples the inclusion of waste processing in site management contracts (targets and results), performance monitoring of sites by means of indicators, operational experience feedback, looking for and dissemination of "good practices".

EDF has developed packaging solutions for all the waste produced by its NPPs. Most waste conditioning operations are performed on-site, using permanently installed equipment for compacting technological waste or for solidification of concentrates, sludges and water filters in a cement matrix. Ion exchange resins are conditioned using mobile equipment with a

process designed to encapsulate ion exchangers in an epoxy resin matrix. The final waste is packaged in a concrete container lined with steel radiological shielding.

For waste volume reduction, a major development occurred with the commissioning in 1999 of the CENTRACO waste treatment facility, operated by SOCODEI, a 100% owned subsidiary of the EDF Group. This facility offers waste volume reduction services by incineration and metal melting. The CENTRACO incineration unit is designed to process short-lived LL radioactive combustible solid and liquid waste produced in nuclear installations (boots, clothing, wash-liquors, oils, and solvents). The CENTRACO melting unit has the capacity to melt and recycle scrap metal and metallic components produced in nuclear installations during routine operation, during process maintenance and during dismantling.

CENTRACO offers high volume reduction factors in the range from 5 to 20 and more than 90 % of its capacity is used to process EDF LLW. In ten years of operation from 1999 to 2008, CENTRACO has treated by melting and incineration 30 000 m³ of metallic LLW and 43 000 m³ of suitable waste, which came from the EDF PWR fleet. This saved a volume of 64 000 m³ LLW from being sent for disposal, the equivalent of nine years of average usage by EDF of Andra's Low and Medium Activity Disposal Site. The start-up of the CENTRACO facility also enabled the treatment of certain wastes which remained without a management route and which in certain cases were remaining in interim storage on the station sites. Several thousand tonnes of oil and solvents, various aqueous wastes as well as wet and greasy waste have been incinerated.

The large majority of final waste is disposed of in the two Andra's surface repositories in the Aube district : the Soulaines repository for short lived LILW, commissioned in 1993, and the Morvilliers repository for VLLW commissioned in 2003. Today, a few waste categories, for very limited quantities, still do not have complete waste management routes. There are certain types of waste containing asbestos and mercury for which it remains to finalise the practical solutions of conditioning and acceptance in disposal. The principal difficulties to take into account for these wastes lie in their physico-chemical characteristics and not in their radiological characteristics.

Complete and safe management routes from generation to disposal are in operation for the large majority of short-lived waste generated both by power plants in service and during decommissioning, representing 90 % in volume of all the radioactive waste generated by EDF nuclear stations. These routes largely rely on the use of CENTRACO waste processing plant and on Andra's repositories.

Long-lived Radioactive Waste : EDF Experience to Benefit to the Development of the Geological Disposal Centre

In line with national policy, EDF has chosen to reprocess used fuel and thus to recycle plutonium and uranium from reprocessing (RepU) which contributes to the fuel supply of EDF reactors to the extent of 17 % of annual requirement. Reprocessing used fuel allows an outcome of volume reduction of final wastes (long-lived medium and high activity) by a factor about tenfold, which allows a reduction of the use of disposal, but also the need for interim storage capacity. In addition, since launching the PWR nuclear fleet, a continuous improvement of fuel energy efficiency has allowed a 25 % reduction in the fuel quantity used every year, inducing significant reduction on long-lived waste inventories.

For these long-lived wastes and specially the HLW coming from reprocessing of EDF spent nuclear fuel, the 2006 waste act has confirmed the solution of deep geological disposal, with the construction-licence application to start in 2015 and, subject to its approval, the commissioning of the repository to take place in 2025. In the meantime, the HLW is packaged in stainless steel containers after vitrification, allowing their storage during the geological repository development phase with a possible storage duration up to 100 years.

Andra, the national radioactive waste agency, is responsible for siting, designing, implementing and operating the future geological repository called the Cigéo project. EDF, as well as the two other French nuclear operators Areva and CEA, are technically and financially responsible for the waste they generate, with no limit in time. The success of the Cigéo project depends on an effective cooperation between Andra and the three nuclear operators. With this objective in mind, a cooperation agreement between the four parties was implemented in early 2012. This agreement gives a framework to organise technical exchanges and to conduct joint studies between Andra and the nuclear operators. Also the EDF teams have made their industrial experience available to help the design studies carried out by Andra in the framework of the Cigéo project.

Indeed, EDF has a high level of expertise and recognised know-how in the key areas of design and construction of a deep geological repository. This is specially the case for underground facilities, with more than 60 years in the hydropower industry with an important expertise in tunnel construction, maintenance and operation. EDF is the owner and operator of more than 600 galleries and underground passages (1500 km) and 180 shafts in France (a large majority were designed and commissioned by EDF). EDF is also a supplier of engineering services for major hydropower tunnels (Kol Dam, Tehri - India, Doukkala - Morocco) and is operator and designer of new hydroplants with underground structures (Nam Theun - Laos, Rizzanese - Corsica). This experience puts EDF in position to propose solutions for underground facilities and to choose implementation methods (civil engineering, underground working, drilling techniques) and geomechanical design of structures.

Also, its depth of experience as an operator of nuclear facilities allows EDF to propose expertise and proven solutions in terms of operational safety (ventilation), fire protection and fire-fighting (fire doors, fixed structures for fire extinguishing...), safety of workers, which are major issues for any geological repository. In addition, EDF has developed since the 1990s high level skills and numerical simulation capacities in the following areas : geomechanics, thermo-hydro-mechanical modelling, long-term waste package behaviour and long-term safety assessment of an underground repository. Based on these skills and experience, EDF is able to propose technical expertise in terms of geological repository design solution, combined with technico-economical optimisation of the design, thermal optimisation of underground architecture and cost assessment.

EDF a Key Stakeholder for Optimisation and Development of Waste Management Routes

The global management of radioactive waste generated by EDF SA reactors is conducted at a centralised level by its Nuclear Fuel Division (Division Combustible Nucléaire, DCN) in collaboration with the Divisions in charge of NPP operations and of decommissioning, with the objective to guarantee efficient operation of existing routes. Where DCN sees possible advantages, it will offer available alternative processing solutions and it will establish and will implement the management routes for the future. EDF has the position of a key stakeholder in the National Plan for the Management of Radioactive Materials and Wastes (Plan National de Gestion des Matières et Déchets Radioactifs, PNGMDR), being pro-active in the development of waste processing solutions that will reduce the waste quantities to be sent for disposal, as illustrated by the following two examples.

Plant life extension projects for EDF NPPs will generate significant quantities of VLL metallic waste such as steam generators in the frame of a wide-ranging replacement programme on most NPPs. With the anticipated saturation of the VLLW repository, the development of processing solutions to reduce the volume of VLLW is a major challenge for the next decade. Since there is no free release level allowed by the French regulations, the development of recycling options for large components with low contamination to save disposal capacity can only be contemplated with that recycling occurring within the nuclear industry. The

opportunity of developing an industrial scheme for metal melting and recycling is currently under investigation by EDF.

The reference management solution for the graphite waste coming from the dismantling of gas-cooled reactors is a sub-surface repository as planned in the 2006 waste act. However, the site selection process for this repository failed in 2009 and was suspended in 2010, inducing a delay interfering with the on-going decommissioning programme and putting a high risk on cost and planning. To mitigate this risk, EDF had launched in 2008 laboratory testing to assess the possibility for C-14 and Cl-36 decontamination through thermal treatment of irradiated graphite. Following the promising results obtained so far, larger scale tests will be performed to assess by 2015 the industrial feasibility of thermal treatment, with the objective to provide an alternative solution to direct disposal.

Conclusion

On a European level, the increased awareness of the general public and authorities of the issue of radioactive waste, combined with the potential of early decommissioning of power plants in countries that have decided to phase out nuclear power, will lead certain countries to anticipate the planning of the implementation of solutions for their waste. EDF is able to provide them with recognised technical expertise on waste management solutions as consultant, process supplier or service provider according to need and type of contract.

ADVANCES IN LASER CUTTING AS A DECOMMISSIONING AND DISMANTLING TOOL

P.A. HILTON, A. KHAN
TWI Ltd
Granta Park, Cambridge, CB21 6AL, UK

R. BUCKINGHAM
OC Robotics Ltd
Abbey Wood Business Park, Filton, Bristol, BS34 7JU, UK

ABSTRACT

This paper will describe recent advances and work to highlight the advantages (and problems) when applying high power laser cutting to aspects of decommissioning and dismantling in the nuclear sector. Work to describe single sided cutting of tubular structures using a 5kW laser, with the objective of size reduction for long term storage, was presented at ENC 2010. Since then further work to establish the cutting capability of the same laser for plate materials and structures such as rolled and fabricated beams and other welded constructions, such as waste storage containers, has been undertaken and the results will be presented. In addition, video of the process for selected potential applications will be shown. Further work has linked the laser cutting head to a snake arm robot, and with this system a demonstrator set up was constructed to show the cutting head entering a cell through a typical access port, cutting a hole in the side of a simulated containment wall and then proceeding to cut out a selection of tubes to gain access to a part to be removed. Again, video footage of this demonstration will be shown. The paper will also discuss aspects of establishing a safety case for use of high power laser cutting in nuclear environments.

1. Introduction

Laser cutting is just one of a set of tools which may be useful in aspects of decommissioning, particularly that of size reduction for long term storage. Laser cutting can be compared to both mechanical cutting and also other thermal cutting processes used in decommissioning such as plasma cutting. Some of the benefits of laser cutting, when compared to mechanical cutting, include the lack of a reaction force between the cutting head and the material being cut, which means that lightweight deployment systems can be employed and as a result the mass/volume of secondary waste produced can be kept much smaller. Compared to other thermal cutting processes, laser cutting generally produces less cutting debris (due to the small kerfs possible) [1] and less fume, thus reducing the load on ventilation systems. Laser cutting also allows for single sided cutting of tubular structures and pipework [2] which is a big advantage compared to processes which must rotate around a tube in order to be able to cut it. In laser cutting where the capability to simply sever the material is more important than maintaining cut quality, the tolerance to cutting head standoff can be arranged to be high by employing high brightness lasers and long focal length cutting optics. In addition, with some thermal cutting processes, standoff constraints and the physical geometry of the cutting heads reduce flexibility of applied cutting paths. The large standoff tolerance and cut path flexibility offered by laser cutting is highly beneficial for remote cutting operations.

The reliability of today's high power industrial lasers has been proven in the automotive industry. Very high powers (50+kW) can be transmitted down flexible fibre optics to a lightweight cutting head. Such fibre optic cables can be long and employ in-line connectors. This means that not only can the relatively expensive laser source be maintained in a clean environment but also that only relatively small amounts of fibre optic need to be used in the

active areas. As the laser and the main delivery fibres can be used repeatedly, this reduces the potential cost of multiple decommissioning activities. There are also some current disadvantages to laser cutting, which are still being addressed. Amongst these includes the generic development of a safety case for use of laser cutting and within this, some of the important issues include management of the laser beam energy transmitted through the part being cut and the temperatures generated in the process. This paper will describe additional laser cutting information on plate materials and then go on to describe work performed to assist development of a safety case before concluding with descriptions of two significant demonstrations of the application of remote laser decommissioning.

2. Laser Cutting of Plate Material

2.1 Experimental procedures

In this series of experiments, the beam from a 5kW laser was used to cut carbon manganese steel plates, between 6 and 50mm in thickness and stainless steel plates, between 6 and 25mm in thickness. The beam from the laser was transmitted to the cutting head in use using a 150micron diameter optical fibre. In such laser cutting systems, the laser light arriving at the cutting head from the optical fibre, first expands as it leaves the fibre and is then made parallel by an optical collimation system. An additional optic then focuses the laser light to a very small spot to create the power density needed for cutting. The TWI heads developed for decommissioning use lenses of long focal lengths, (250 and 500mm), to provide a low laser beam divergence, and hence high depth of focus. The corresponding minimum focal spot diameters for these lenses were 0.3 and 0.43mm respectively.

For both lenses, the laser beam was focused through a cutting nozzle tip with an exit diameter of about 3.5mm, in which the beam was centrally aligned. Each nozzle provided a distance of 15mm between the laser beam focus and the extremity of the nozzle tip. In conventional laser cutting, these distances are only of the order 1mm. In this paper, the 'standoff distance' is defined as the distance between the nozzle tip and the material surface being cut. The 'focal position' is defined as the distance between the laser focus position and the surface of the material being cut. Compressed air was used as the cutting assist gas through the cutting nozzle. In use, each process head was mounted on the arm of a Kawasaki articulated arm robot.

During experiments two laser powers of 2 and 5kW were used with each focusing lens and the standoff distance was varied between 5 and 25mm. Cutting gas pressure was varied between 8 and 10bars. During cutting experiments the speed of the beam over the material was varied to identify the maximum cutting speed needed to sever the material in two. The basic definition of an acceptable cut in relation to decommissioning is simply the ability to separate a structure, irrespective of the cut quality. Cut surfaces that were re-fused (welded) or obstructed from free fall by the attached dross were considered as not cut. In the results below, the 'maximum cutting speed' is the fastest speed that achieved a cut as defined above, in a single-pass of the beam.

On the various materials investigated, to optimise a particular cut or cutting sequence, the procedure involved fixing the laser power and assist gas pressure, setting the standoff distance between the nozzle tip and the material surface (thereby adjusting the position of the point of maximum power density), and then adjusting the cutting speed until the material could not be cut in a single-pass. Using the maximum attainable cutting speed for each sequence, a slot was then cut for kerf width analysis and material removal rate calculations.

2.2 Results and discussion

Figures 1 and 2 show the results of plotting the maximum laser cutting speed against the material thickness for the CMn steel, at the two laser powers used and for each focusing lens. Two extremes of standoff distance are also included, 5mm (ie close to the nozzle tip) and 25mm (ie far from the nozzle tip). These results show, as expected, that the cutting speed drops (for either lens) as the material thickness increases. However, the differences due to choice of focusing lens are not particularly great. In addition, the results at the two

extremes of standoff distance are also not large, indicating the high tolerance of the laser cutting process used in this mode of 'severing'.

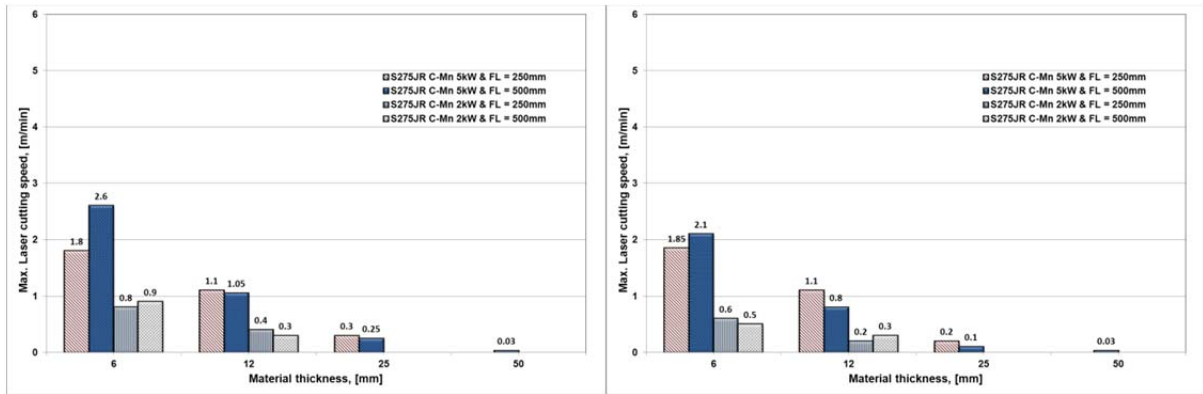

Fig 1. Cutting results on CMn steel 25mm stand-off (left) 5mm stand-off (right)

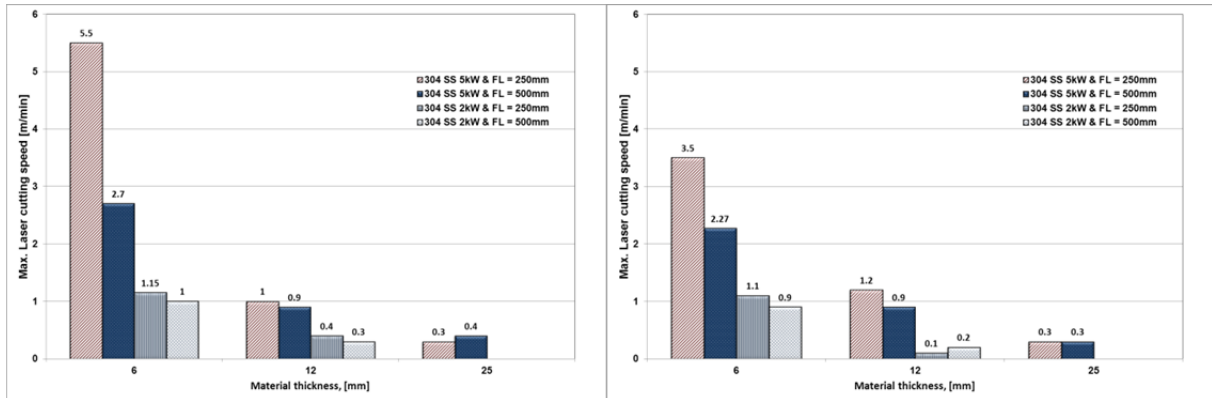

Fig 2. Cutting results on stainless steel 25mm stand-off (left) 5mm stand-off (right)

As seen in Figure 2, the trend was similar for cutting stainless steel, although higher cutting speeds were recorded for the thinner materials. The maximum cutting speeds obtained when using the 500mm focusing lens, determined for particular combinations of laser power and standoff distance, were used to cut simple kerf slots in the 6 and 12mm thickness C-Mn and stainless steel plates. Selected cross-sectional images of such kerfs for CMn steel are shown in Figure 3, and for stainless steel in Figure 4 at a laser power of 5kW.

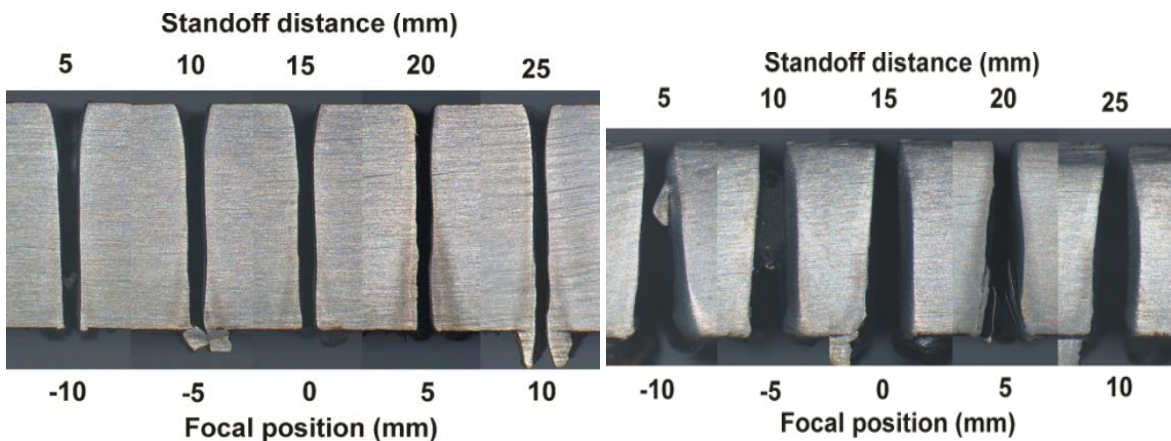

Fig 3. Kerf cross-sections for 12mm thickness CMn steel (left) and 6mm CMn steel (right).

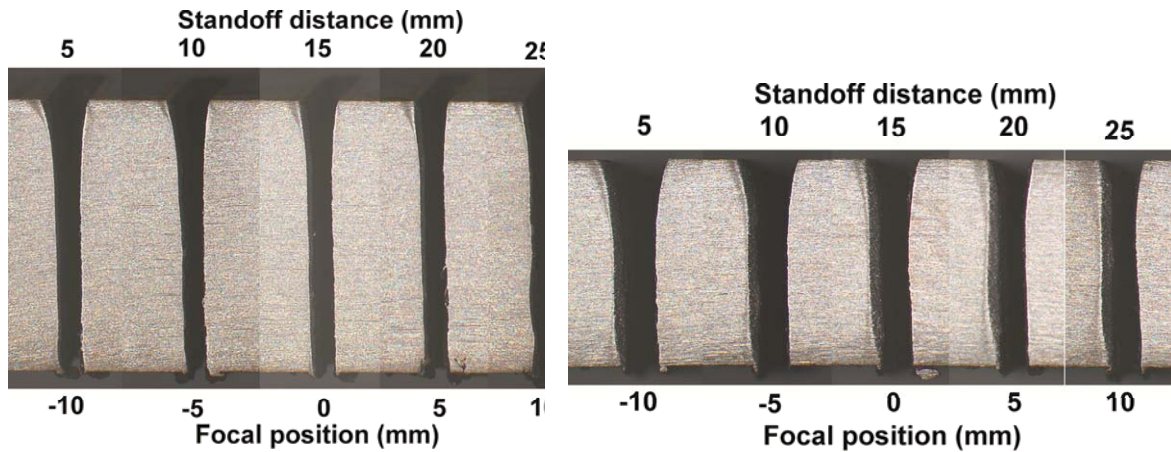

Fig 4. Kerf cross-sections for (left) 12mm thickness stainless steel and (right) 6mm stainless steel

The kerfs were sectioned and their areas were measured. Material removal rates (g/min) were calculated for each kerf. The material removal rate can be considered as the product of the material density, the kerf cross-sectional area and the cutting speed. These properties are influenced by the ratio between the combined energy input from laser beam absorption and gas-jet momentum to the energy released during the melting of the material. The calculated material removal rates are presented in Figure 5, for both stainless and CMn steels and at both laser powers investigated.

For constant laser focusing conditions, this relationship suggests that the material removal rate is directly proportional to the combined laser and gas-jet power, and the physical properties of the materials being cut. This can be seen in Figure 5, where higher laser power generates higher melting rate which is easily expelled by the assist gas-jet. Differences in material properties between C-Mn and stainless steels will result in different melting rates, which can affect the melt expulsion efficiency. The difference in material removal rate between C-Mn and stainless steel is most dependent of the chemical composition, and the difference appears to increase with laser power. Analysis of the kerf cross-sections indicated that the main difference in the melt ejection rates between the two materials could be attributed to side-ways burning of the C-Mn steel during cutting. Such burning probably affects the melt flow.

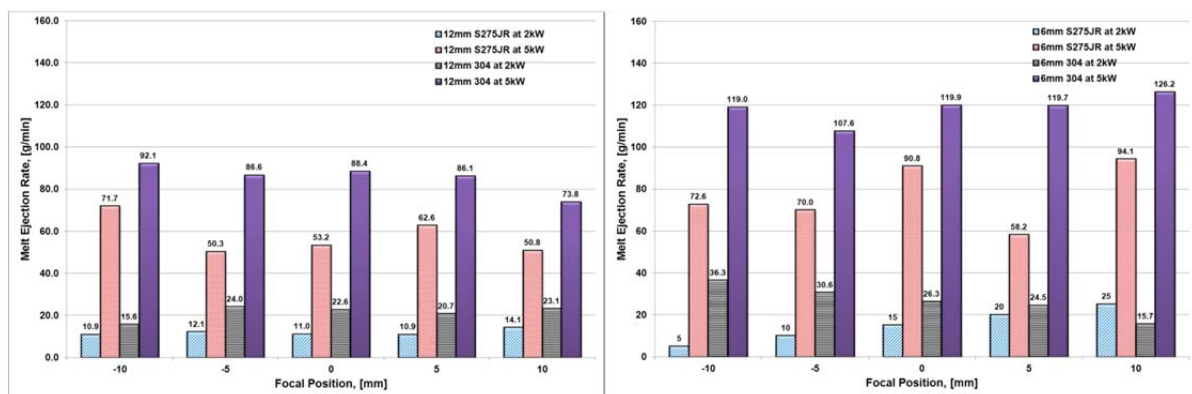

Fig 5. Material removal rate as a function of focal positions corresponding to standoff distances between 5 and 25mm for 6 and 12mm thickness material and two laser powers.

The side-ways burning of the surrounding material is likely due to the exothermic reaction between the higher carbon content in the C-Mn steel and 20% oxygen in the compressed air gas-jet. Side-ways burning was also present in 12mm thickness C-Mn steel, but was not as pronounced as seen in the 6mm thickness material. Nevertheless, this did result in changes to the kerf cross-sectional areas, which are reflected in the material removal rate results. As presented, the results show the removal rate to be much higher for 5kW than 2kW but it must

be remembered that at 2kW, the cutting speed is significantly reduced. In remote laser decommissioning of contaminated nuclear components it is desirable to achieve minimum material removal rate.

This implies that the kerf has to be narrow and the subsequent cross-sectional area needs to be small. The result will produce a minimum level of fume and will result in longer operational life for cell filtration systems. Such optimised cutting is probably possible when size reducing flat structures but might be difficult when cutting pipework from one side or more complex shapes. Figures 6, 7, 8 and 9 show some of the geometries decommissioning cutting techniques have been established for.



Fig 6. Section from a curved vessel.



Fig 7. Method to dismantle I beam.



Fig 8. T profile in CMn steel cut in a single pass



Fig 9. Structural concrete

3. Safety Case Considerations

Before deploying any new technology in an active decommissioning environment, it is an obligatory requirement to assess all possible hazards that may arise. TWI has attempted to identify possible risks associated with remote deployment of high power laser systems by way of a paper based HAZOP assessment for using fibre delivered laser beams for size reduction in a typical active cell. This centred on three key stages of the decommissioning process, which included deployment of the laser cutting tool and laser beam generator, the

cutting process itself and waste and waste recovery processes. The HAZOP assessment of the first two stages above highlighted the following for future attention if a safety case for using laser cutting is to be established:

- Effects of stray laser beams passing through the material being cut.
- Heat and temperature generation associated with laser cutting.
- Assessment of the variety of materials to be cut and their interaction with laser light.
- Release of possible contents (from items such as pipes or vessels being cut).
- Fume generation arising from laser cutting.
- Laser safety (health hazard to operators and others).
- Unintended laser cutting, for example of something revealed behind a part being cut.
- Maintenance of the laser cutting head.

Evaluations to address the above are currently on-going.

4. Demonstrator Activities for Laser Cutting in Decommissioning

This section will address two demonstration activities TWI have recently been involved in. The first involved trials on painted mild-steel skips of the type normally used for storage of irradiated nuclear fuel elements and having a volume of about one cubic metre. Because of growing space limitations, many of these empty skips need to be size reduced. A possible solution is to place the parts from cut skips back into a skip of a similar size. As a result, a process which offers the flexibility to quickly cut skips to maximise resulting packing density is required. TWI have demonstrated cutting of such skips, using a 5kW laser beam and the type of cutting head described above, connected to an articulated arm robot. Using a pre-programmed cutting path, it was possible to reduce a single skip to resulting volume such that four size reduced skips could be comfortably stored in a single skip of the same original size.

The second is the 'LaserSnake' project. This project was undertaken in conjunction OC Robotics Ltd, to investigate a unique system combining the cutting power of a high power laser with the access capability and manoeuvrability offered by a snake-arm robot. The demonstration involved a selective and remotely-controlled approach to dismantling and decommissioning complex structures in hazardous and confined nuclear environments.

A mock-up cell (2.5m x 2.2m x 1.5m) containing a 1m long 150mm diameter access aperture, a pressure vessel wall and a subsequent arrangement of pipework, was constructed. The demonstration showed the system entering the cell, avoiding an obstacle and then cutting an access hole in the wall of the pressure vessel. The cutting head on the tip of the snake robot, then entered the pressure vessel to inspect the pipework and subsequently selected, using its on-board vision system, the targets that required cutting, before re-tracing its movements to finally withdraw itself from the cell.

5. References

- [1] Pilot Guy et al., 2008: 'Measurement of secondary emissions during laser cutting of steel equipment', Nuclear Engineering and Design. Vol. 238, no. 8, pp2124-2134, August.
- [2] Hilton P et al., 2010: 'The laser alternative in nuclear decommissioning - tube cutting and concrete scabbling using the latest technology', Nuclear Engineering International, Vol. 55, no. 672, July.

TWI and OC Robotics would like to acknowledge the support of the UK's Technology Strategy Board in completion of the above mentioned LaserSnake project.

CONDITIONAL REUSE - PERSPECTIVE METHOD IN THE DECOMMISSIONING MATERIALS MANAGEMENT PROCESS

MATEJ ZACHAR, VLADIMIR DANISKA

DECOM, a.s.

Sibirska 1, 917 01 Trnava - Slovakia

VLADIMIR NECAS

Slovak University of Technology in Bratislava, Faculty of Electrical Engineering and Information Technology

Ilkovicova 3, 812 19 Bratislava - Slovakia

ABSTRACT

The management of materials is considered to be one of the key issues within the nuclear installation decommissioning process. The reason is that the decommissioning process is characterized by production of large amount of materials with various physical, chemical, toxic and radiological characteristics which have to be managed in a safe and economic way. Significant part of decommissioning materials, for which the relevant radiological limits are not exceeded, could be released to the environment without any restriction for their further use - unconditional release. The materials with higher content of radioactivity are considered to be a radioactive waste finally disposed in the repository. On the other hand there are materials with radioactivity slightly above the levels for unconditional release and they could be released conditionally, it means the scenario of specific industrial application with some restrictions for further reuse is developed and evaluated. The fulfilment of scenario conditions ensures that the exposure limits of personnel and public will not be exceeded.

The main aim of the presented paper is to summarize the methodology and up to date results of the research project CONRELMAT dealing with complex assessment of scenarios for conditional reuse of decommissioning materials in the environment. Conditionally released materials, mainly steel and recycled concrete, could be used in the constructions with long-term stability, long-term planned use and where the minimum interaction of public with materials is expected. On the other hand, the possibility of reuse of such materials within nuclear industry is also in the scope of the project.

The assessment of scenarios for conditional reuse of materials consists of the identification and evaluation of all activities which could lead to the exposure of personnel or public. With appropriate calculation tools (Visiplan 3D ALARA Planning tool and GoldSim), the external and internal exposure are evaluated and the maximum levels of radioactivity concentration in the materials ($Bq.g^{-1}$), for which the dose limits are not broken, are derived. Then the decommissioning costing and planning code OMEGA is used for calculation of the amount of materials from decommissioning, fulfilling the previously calculated limits for conditional reuse.

Respecting the mentioned safety requirements, the non-negligible amount of decommissioning materials could be conditionally reused without significant radiological impact on the personnel (workers), public and environment.

1. Introduction

The nuclear installation (NI) decommissioning is generally characterised as a complex process that includes various technological (decontamination, dismantling, demolition, waste management, radiological surveys) and also administrative (projects preparation, equipment procurement, personnel training, project management) activities necessary to be done to achieve the removal of the former NI site from the control of regulatory body.

As a result of mentioned decommissioning activities a wide range of material (waste) types arises. They are usually different from the types generated during operational period or routine maintenance of the NI. The amount and physical, chemical, toxic or radiological characteristics of decommissioning materials are strongly influenced by the type of nuclear power plant reactor, construction materials, characteristics of the operational period (duration, chemistry, maintenance, number and seriousness of accidents) and chosen decommissioning strategy.

All activities done in the decommissioning materials or waste management process are aimed to achieve the two main goals:

- Release the materials to the environment (ENV);
- Safe isolation of the non-releasable materials from the environment within the radioactive waste (RAW) repository barriers.

In the next chapter of the paper the process of materials releasing and reusing is discussed more in details.

2. Release of materials from decommissioning process - overview

Release (clearance) of the materials from regulatory control is defined as the removal of all radiological restrictions on the further use of such materials outside NI site. The releasing process is based on the concept of triviality of exposure, generally taken to mean that radiation risks to individuals and collective radiological impact, caused by the released material, is sufficiently low. In quantitative terms, the mentioned state is related to the stipulation that the effective dose expected to be incurred by any member of the public due to the released materials is of the order of 10 μSv or less during one year. Collective effective dose is proposed to be lower than 1 $\text{manSv}\cdot\text{year}^{-1}$ [1], [2].

Mentioned and internationally recommended concept 10 $\mu\text{Sv}\cdot\text{year}^{-1}$ /1 $\text{manSv}\cdot\text{year}^{-1}$ creates a basis for derivation of unconditional release levels for surface contamination ($\text{Bq}\cdot\text{m}^{-2}$) and mass activity - concentration ($\text{Bq}\cdot\text{g}^{-1}$). The overview of these levels for important radionuclides from the decommissioning point of view recommended by IAEA [2], EC [3] (rounded values) and defined by Slovak legislation [4] is given in Tab 1.

Radionuclide		³ H	¹⁴ C	⁶⁰ Co	⁶³ Ni	⁹⁰ Sr	¹²⁹ I	¹³⁷ Cs	²³⁹ Pu	²⁴¹ Am
Mass activity ($\text{Bq}\cdot\text{g}^{-1}$)	IAEA	100	1	0,1	100	1	0,01	0,1	0,1	0,1
	EC	100	10	0,1	100	1	0,1	1	0,1	0,1
	Slovakia	3000	300	0,3	3000	3	30	0,3	0,3	0,3

Tab 1. Examples of unconditional release levels for selected radionuclides

Considering the amount of materials to be released unconditionally, the ratio of releasable materials from the dismantling within the controlled area (main reactor building and active auxiliary building) of VVER-440 reactors (Russian type of pressurized water reactor) is more than 75 % respecting the release levels defined in the Slovak legislation [4]. About 1 % of materials is represented by the long-lived low and intermediate level RAW disposable only in the deep geological repository and the rest is short-lived low and intermediate level RAW aimed to be disposed in the near surface repository type [5]. Of course, all decommissioning materials from buildings outside controlled area are a priori considered to be non-radioactive and are unconditionally released to the ENV.

The unconditionally released materials could be reused in the environment without any restriction from radiological point of view. Generally speaking, the materials could be:

- Recycled and reused in any industrial area (usable materials - mainly metals) or within nuclear industry;
- Disposed on the conventional waste dump or special (toxic or hazardous materials) dump - no practical or economical reason for further reuse exists (non-usable materials are mainly non-metal materials).

On the other hand, the materials with radioactivity slightly above the unconditional levels could be released conditionally i.e. for specific application. But the basic mentioned principle $10 \mu\text{Sv}\cdot\text{year}^{-1}/1 \text{ manSv}\cdot\text{year}^{-1}$ (individual dose could be also higher e.g. Slovak legislation [4] define the limit $50 \mu\text{Sv}\cdot\text{year}^{-1}$ considering specific conditions) has to be followed. The definition of specific options or scenarios for conditional reuse of materials, followed by their assessment aimed to demonstrate that this concept could be applicable, is the main goal of the research project CONRELMAT (CONditional RElease of MATerials) which main points are discussed in the next parts of this paper.

3. Potential scenarios for conditional reuse of decommissioning materials

The definition of scenarios for potential conditional reuse of decommissioning materials in the environment is the first logical step in the evaluation process. The following criteria were set for potential constructions and structures in the environment:

- Long term stability and guaranteeing the long term preservation of original design characteristics of constructions or structures;
- Long term planned use (several decades);
- Materials are either embedded into non-radioactive construction materials (e.g. reinforcement bars in concrete) or limited access of public is expected due to the construction features and conditions of use.

Two material types from decommissioning are considered to be the optimal for further conditional reuse:

- Recycled steel in the form of melted ingots;
- Recycled concrete.

Taking into account the previously mentioned criteria and material types following options, presenting the typical representative structures, are considered and assessed with the frame of project CONRELMAT:

- Manufacturing of metallurgical construction elements;
- Application in railways construction;
- Bridges construction (railway, road - steel);
- High-voltage poles (electricity distribution grids);
- Assembled steel halls;
- Large-size pipelines;
- Tunnel constructions (steel construction elements);
- Prefabricated and monolithic reinforced concrete structures (reinforcement bars);
- Retention tanks (reinforcement bars);
- Dam structures (reinforcement bars);
- Motorway scenario (road embankment) - only one scenario with application of recycled concrete;
- Big storage tanks in NPP controlled area.

The conditional reuse of steel or concrete in the industrial applications listed above expects the releasing of materials to the environment but recycling is recommended to be done within the nuclear sites.

On the other hand there is also a possibility to reuse such materials in the nuclear industry it means that all steps of processing up to reuse are done within the nuclear site. This approach, except of reducing the waste volume for disposal, could lead also to significant savings because the campaigns for releasing of materials to the environment are not necessary. What is more it seems to be a publicly more accepted solution to keep the decommissioning materials within the nuclear sites boundaries. The construction of big storage stainless steel tanks in nuclear power plant controlled area was chosen as a representative scenario for the project purposes. Other examples for reusing the materials within the nuclear industry are fabrication of waste packages (drums, casks), incorporation of

them into reinforced concrete structures of RAW repositories (storages), manufacturing of waste processing equipment (supercompactor) or backfilling of RAW repositories [6].

4. Methodology for scenarios assessment

Chapter describes in details the methodology for assessment of previously mentioned scenarios for conditional reuse of materials. The methodology could be defined in following steps (Fig 1.) [7-9]:

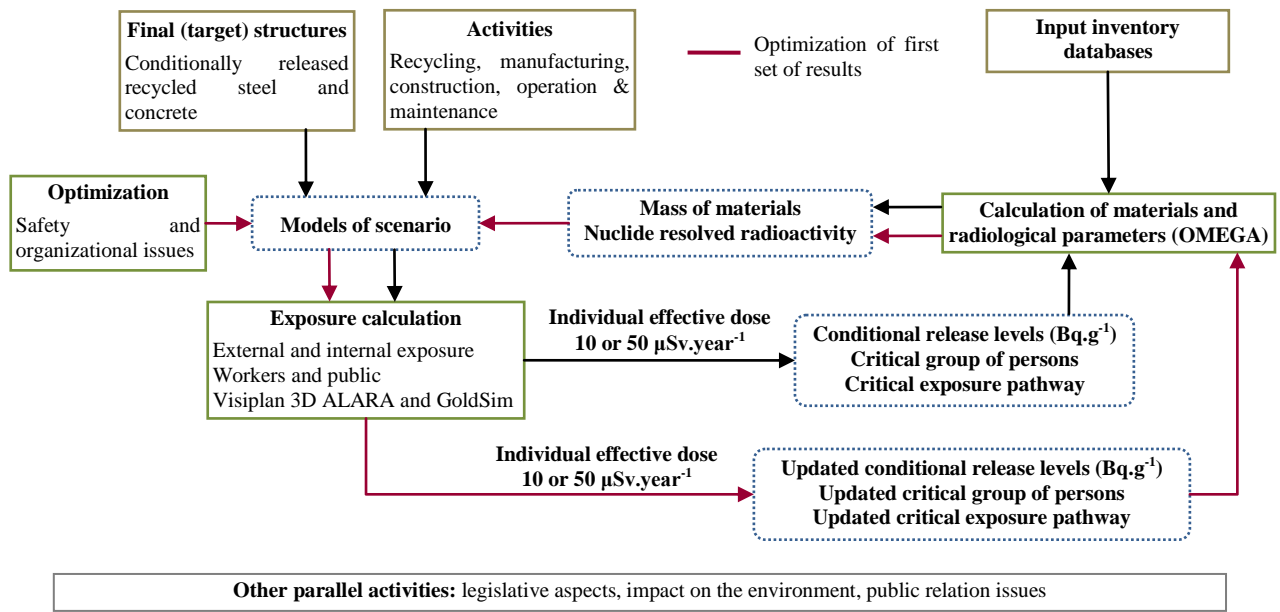

Fig 1. Methodology for assessment of scenarios for conditional reuse of materials

- A. **Definition of final (target) structures** for application of conditionally released materials (e.g. bridge, tunnel) i.e. characterization of their end state.
- B. **Identification of activities** during whole life cycle of structures with conditionally released materials starting from recycling of decommissioning materials (e.g. melting of steel), manufacturing of construction elements (reinforcement bars, rolled steel sheets), construction of structures itself and ending with operation and maintenance - including the possible interaction of public with the structures.
- C. **Creation of the models** of structures end states and other relevant scenarios activities applied for exposure evaluation in relevant calculation tools.
- D. **Evaluation of exposure of workers and public** during whole life cycle of scenario structures and considering all relevant exposure pathways - external exposure and internal exposure. For calculation of individual effective dose caused by gamma emitters (external exposure) the computer code Visiplan 3D ALARA Planning tool is used (short-term periods) - Fig 2. The code GoldSim is used for assessment of long-term impact (external and internal exposure) based on the modelling of structures degradation processes and modelling of radionuclides migration from the structures through the environment - Fig 3. The interim exposure was in some cases, especially for the recycling or elements manufacturing periods, calculating based on parameters and approaches applied in international recommendations [10].

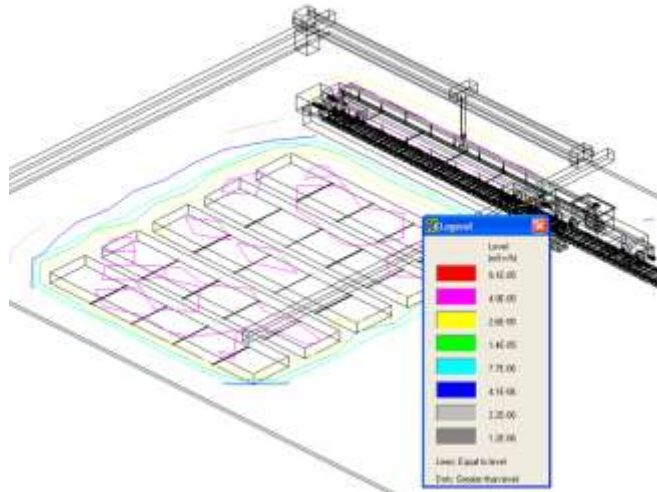

Fig 2. Example of dose map for model of big storage tank installation in Visiplan 3D ALARA [8]

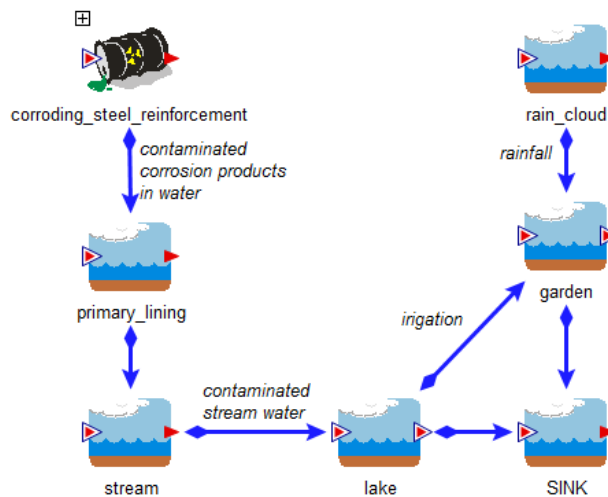

Fig 3. Example of conceptual model of tunnel scenario in the GoldSim code [13]

E. **Derivation of conditional release levels** for relevant individual radionuclides i.e. maximum concentration ($\text{Bq}\cdot\text{g}^{-1}$) of radioactivity for which the limits for effective dose for member of critical group of persons (10 or $50 \mu\text{Sv}\cdot\text{year}^{-1}$) is not exceeded. The critical group of persons (e.g. workers performing the construction) and critical exposure pathway are also determined in this step.

F. **Calculation of material and radiological parameters** of conditionally released materials using the decommissioning planning and costing code OMEGA with newly created and implemented calculation stream evaluating the conditional release parameters [11], [12]. The necessary inputs for calculation are:

- Input inventory database based on the real databases of nuclear installations in Slovakia (VVER reactors, gas cooled reactor);
- Conditional release levels derived in the previous steps of assessment.

The outputs from the OMEGA calculation run are:

- Mass of materials to be released conditionally;
- Nuclide resolved radiological parameters of these materials.

G. **Optimization of the models** by improving safety or organizational means of the scenarios (e.g. additional shielding, organization of working shifts). As a result of this

process the new conditional release levels are obtained and they could be repeatedly loaded to the OMEGA for another calculation run.

H. **Other parallel activities to support scenarios** such as legislative aspects of conditional release; impact of the process on the environment, public relation issues.

5. General results

Considering up to date status of the evaluation of scenarios for conditional reuse of materials it could be said that for most of them the models are done and evaluation is in the process. From the preliminary results that were obtained by evaluation of the selected scenarios it is possible to give following general conclusions:

- Maximum radioactivity concentration of materials (Bq.g^{-1}) that could be released for conditional reuse without exceeding the exposure limits are, for some cases, about one order of magnitude higher comparing with limits for unconditional release defined in Slovak legislation i.e. up to ten of Bq.g^{-1} for radionuclides in the highest class of radiotoxicity e.g. ^{60}Co , ^{137}Cs or alpha emitting radionuclides (see Tab 1.);
- To calculate the amount of materials, several screening calculations in the OMEGA code with various release levels for various nuclides were done. To summarize the results, the amount of materials to be released conditionally varied in the interval of hundreds up to one or two thousand of tons depending on the type and parameters of input inventory database. Considering the previously mentioned database of main reactor building and active auxiliary building of power plant with VVER-440 reactors, the ratio of materials to be released conditionally is about 4-10 %.
- Critical exposure pathway and also the critical group of person is different depending on the radionuclides characteristics (volatility, type of emitting radiation, radiotoxicity etc.) and no general conclusion could be said in this field;
- Process of primary materials recycling after dismantling, especially metal melting, has significant impact on the radiological parameters of released steel materials because during melting volatile nuclides (^{137}Cs , ^{90}Sr and actinides) are almost completely eliminated from the steel ingots to secondary radioactive waste (slag, dust) and in usable ingots remains mainly the activation products of steel components (^{55}Fe , ^{60}Co , ^{63}Ni). What is more, the radioactivity is homogeneously distributed in the ingot volume and surface contamination is eliminated which facilitates the characterization process before releasing of ingots for further reuse.

6. Conclusion

The paper presents the general overview of concept of releasing the decommissioning materials to the environment but the main part discusses the methodology and preliminary achieved general results of the research project CONRELMAT dealing with identification and assessment of potential options for conditional reuse of materials in the industrial application. The assessment of defined scenarios is aimed to stipulate the conditional release levels (Bq.g^{-1}) for individual radionuclides, critical exposure pathway and amount of materials to be released conditionally in accordance with developed and evaluated scenario.

Based on the previously mentioned results it is possible to conclude that the presented concept of conditional release of materials is feasible and its application could increase the amount of decommissioning materials to be recycled in a safe way i.e. the legislatively defined limits for annual doses of workers or public are not exceeded. The conditionally released materials are not managed as a radioactive waste and disposal capacity in repositories is saved.

Outputs and results from scenarios evaluation are gathered creating the systematic general sample database (used procedures, metrology and numerical data) which can be used in future as a source of information for possible real application of reusing the conditional released materials.

Anyway, before the real application of presented approach, it will be important and necessary to discuss the issue of conditional release with all relevant stakeholders (e.g. industry, government bodies, members of the public) and to clearly define the legislative framework.

7. Acknowledgements

This project has been partially supported by the Ministry of Education by decree No. CD-2009-36909/39460-1:11 within the bounds of project CONRELMAT.

8. References

- [1] OECD/NEA. Release of Radioactive Materials and Buildings from Regulatory Control. Paris: OECD/NEA (2008). ISBN 978-92-64-99061-6.
- [2] International Atomic Energy Agency. Application of the Concepts of Exclusion, Exemption and Clearance: Safety Guide No. RS-G-1.7. Vienna: IAEA (2004). ISBN 92-0-109404-7.
- [3] European Commission. Radiation Protection 122. Practical Use of the Concepts of Clearance and Exemption - Part I: Guidance on General Clearance Levels for Practices. EC, 2000.
- [4] Statutory Order No. 345/2006 on the Basic Safety Requirements on Personnel and Public Health Protection against Ionizing Radiation (in Slovak).
- [5] NOVÁK, M. et al. Conceptual decommissioning plan EBO V2 NPP. DECONTA, a.s., Trnava, April 2008.
- [6] International Atomic Energy Agency. Managing Low Radioactivity Material from the Decommissioning of Nuclear Facilities: Technical report series No.462. Vienna: IAEA (2008).
- [7] Daniška, V. et al. Reuse of Conditionally Released Materials from Decommissioning; A Review of Approaches and Scenarios with Long-Term Constructions. In: Proceedings of the 14th International Conference on Environmental Remediation and Radioactive Waste Management (ICEM2011). September 25-29, 2011, Reims, France. [CD-Rom].
- [8] Vaško, M., Daniška, V. Nečas, V. Investigation of Appropriate Applications for Reuse of Conditionally Released Materials from Decommissioning. In: Proceedings of the Proceedings of the 9th International Conference on Nuclear Option in Countries with Small and Medium Electricity Grids. June 3-6, 2012, Zadar, Croatia. ISBN 978-953-55224-4-7. [USB disk].
- [9] Hrnčíř, T., Nečas, V. Radiation Impact of Very Low Level Radioactive Steel Reused in Motorway Tunnel Constructions. Paper presented on ICRS-12. September 2-7, 2012, Nara, Japan.
- [10] International Atomic Energy Agency. Derivation of Activity Concentrations Values for Exclusion, Exemption and Clearance: Safety Reports Series No.44. Vienna: IAEA (2005).
- [11] Zachar, M., Daniška, V., Nečas, V. Improved analytical methodology for calculation assessment of material parameters in the nuclear installation decommissioning process. In: Progress in Nuclear Energy. Vol.53, Issue 5, July 2011, p.463-470.
- [12] Zachar, M., Daniška, V., Nečas, V. Methodology for Identification of Conditionally Released Materials from Decommissioning Using the OMEGA Code. In: Proceedings of the 14th International Conference on Environmental Remediation and Radioactive Waste Management (ICEM2011). September 25-29, 2011, Reims, France. [CD-Rom].
- [13] Panik, M., Nečas, V. Long-Term Radiation Impact of Conditionally Cleared Radioactive Material from Decommissioning of Nuclear Power Plants Reused In Building Industry. Paper presented on ICRS-12. September 2-7, 2012, Nara, Japan.

ENC
2012

EUROPEAN NUCLEAR CONFERENCE



END OF USE: STORAGE/DISPOSAL

CIGÉO, THE FRENCH GEOLOGICAL REPOSITORY PROJECT

T.LABALLETTE, A.HARMAN, MC.DUPOUIS, G.OUZOUNIAN

ANDRA – 1-7 rue Jean Monnet, 92298, Châtenay-Malabry Cedex, France

ABSTRACT

One of the major projects in ANDRA, the French National Agency for Radioactive Waste Management, is to prepare CIGÉO, the geological repository for high-level and intermediate-level long-lived radioactive waste, and to commission it by 2025. The legal framework is defined by the 2006 Act. The project progresses on two fronts.

The first one is on siting. A significant milestone was reached in late 2009 with the definition of an area where the underground repository facilities will be located. This area was approved in March 2010 by the Government, after having collected the opinions and positions of all the interested parties, at both National and local levels. A new phase of dialogue with local stakeholders is now ongoing to refine the implementation scenarios of surface facilities. The final site selection will be approved after a public debate planned for 2013.

The second one is the industrial organization, planning and costing. A detailed organization with well-defined milestones was set-up. CIGÉO will be a specific nuclear facility, built and operated underground for over a hundred years. The consequence of this long duration is that the development of the repository facilities will take place in successive operational phases. The characteristics of the first waste packages received will determine the work and the corresponding investments by 2025 on the repository site.

1. Introduction

The main concern for radioactive waste management is that safety be achieved for today and for the coming generations. The French State will take care of the environment and public health, no matter what the nuclear industry does, especially given the timeframes for the radioactivity to disappear. ANDRA was launched as a public Agency for this purpose, and reports directly to 3 ministries, the one in charge of energy, that for environment and last for research.

Such an important issue needs a wide public involvement and control from the civil society. Dedicated structures were launched to reach the best possible confidence level and to demonstrate that safety can be achieved through solutions developed by ANDRA. The control system relies on three bodies:

- Firstly, the National Evaluation Board (CNE), performing an independent scientific and technical assessment and reporting to the Parliament and to the Government. Its role is to check for the society that the best available knowledge is used to demonstrate the safety and the technical feasibility of the geological repository;

- Secondly, an independent Nuclear Safety Authority (ASN), whose responsibility is to assess the disposal projects from the safety standpoint;
- And thirdly, a Local Information and Oversight Committee (CLIS). Its mission is to oversee a general monitoring, information and consultation process with regards to the geological repository. The CLIS may commission hearings or have independent audits performed.

Last, the Parliament, through its Office for Evaluation of Scientific and Technological options (OPECST), also have control on the development of solutions for radioactive waste management, especially through general political and strategic reviews.

A 15 year timeframe was given by the research law of 1991 to perform research for high-level and intermediate-level long-lived radioactive waste management. Research would include not only the geological disposal but also the long-term interim storage option and partitioning and transmutation. Based on the results and on an extended consultation process, including a National Public Debate, a Planning Act was passed by the Parliament in 2006. The decision was taken to dispose of the high-level and the long-lived radioactive waste in a reversible repository in a deep geological formation. The work performed so far was to progress on the geological repository project now called CIGÉO, for Industrial Disposal Geological Center.

2. Status of CIGÉO

The 15 year period from 1991 to 2006 was mainly dedicated to research activities, especially thanks to an underground laboratory constructed at the border between the Meuse and the Haute-Marne districts, at the Bure location. Following the 2006 Planning Act, work progressively focussed on the siting process for Cigéo and on the preparation of the industrial development of the project.

A license application for the reversible geological repository must be submitted in 2015. Following its review, and, subject to its approval, the creation-licence could be granted in 2018, in order to start the commissioning of the new repository in 2025.

In late 2009, ANDRA submitted to the French government proposals concerning the implementation and the design of CIGÉO. A significant step of the project was completed with the delineation of an interest zone for the construction of the repository's underground facilities in 2010. The selected surface site locations will be validated after the public debate that is scheduled for the first half of 2013. This debate will be organized by the National Public Debate Committee. In parallel, the French State is leading the preparation of a territorial development scheme, which will be presented during the public debate.

The reversibility options for the repository constitute proposals in terms of added flexibility in repository management and in package-recovery levels. They orient the design of the repository in order to promote those reversibility components. They contribute to the dialogue with stakeholders in the preparation of the public debate and of the future act on the reversibility conditions of the repository.

The development of the repository shall be achieved over a long period, around one century. Hence, additional knowledge will be acquired at every new development of the project, notably during the initial phase. The feedback from this first phase may be reused during the following phases, in order to continue to optimise the project. This process is part of the approach proposed by ANDRA in 2009 pursuant to the reversibility principles.

3. The repository Project

Surface installations include nuclear facilities where waste packages will be received, controlled and prepared before disposal. They also include industrial workshops in support of excavation work and the maintenance, administrative buildings, one or several muck-stockpile areas, and 40% of which will be reused for the closure of the repository.

Underground disposal zones are designed in modules in order to allow for a progressive construction of the disposal cells and the sorting of the waste according to their characteristics.

Surface/bottom connections are necessary in order to convey staff, disposal containers, materiel and materials for work activities, as well as utilities, including ventilation and muck extraction. In order to provide extra flexibility in the siting process, ANDRA studied the possibility of opening a linear ramp for package-transfer purposes, thus uncoupling part of the surface installations from the underground ones (figure 1).

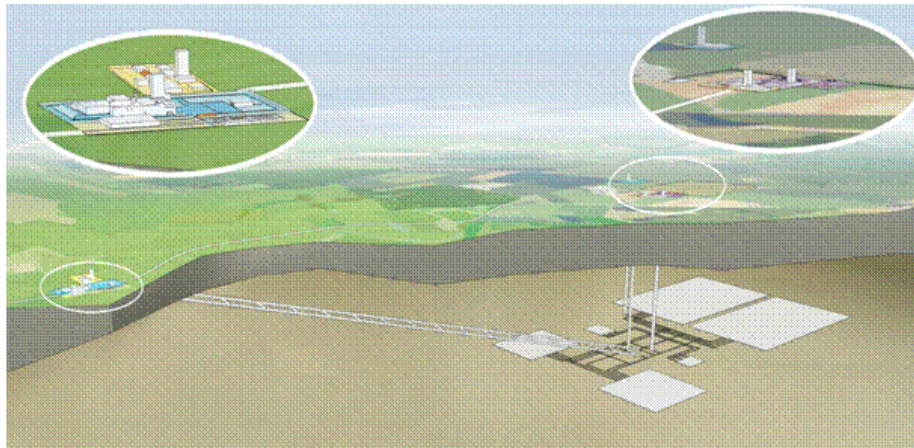

Fig 1. Display of the potential decoupling of certain surface installations through a ramp (indicative concept of the repository after about 100 years in operation)

4. The Implementation of the Repository

Studies and investigations conducted by ANDRA until 2005 showed the feasibility of the repository in an argillite layer of the Callovo-Oxfordian formation that was investigated by the Meuse/Haute-Marne Underground Research Laboratory (URL), at Bure. A 250-km² zone was delineated around the URL where the scientific results achieved on the argillite layer may be transposed.

Based on detailed further investigations results obtained between 2006 and 2009, ANDRA proposed a restricted zone (ZIRA) in the order of 30 km² for the implementation of the underground facilities of the repository, which corresponds to about twice the total expected footprint of the underground facilities after about 100 years of operation.

In March 2010, the French Government validated ANDRA's proposed zone after having received the positive opinion of the local communities represented by the CLIS, of French Nuclear Safety Authority (ASN) and of the CNE. The comprehensive 3-D seismic survey campaign took place during the spring and summer of 2010, and the first results confirmed the absence of any faults, even minor, affecting the Callovo-Oxfordian formation in the ZIRA.

The French Government also took note of the wish of the Meuse and Haute-Marne Districts to establish a sustainable partnership for hosting the geological repository. ANDRA is requested to study the implementation of the repository's ramp access in the straddling zone between both districts. In response, ANDRA has proposed to study such implementation over a zone located along the border between both districts, and close to the Laboratory. Shafts are located vertically above the underground facilities.

ANDRA is examining the modalities dealing with the insertion of the installations in their environment by taking into account the local expectations, such as the management of surface waters and of excavated muck, releases, landscape insertion, proposal of architectural sketches, worksite management, etc. Facilities and equipment to be developed for the construction and the operation of the CIGÉO (transport infrastructures, location of the railway terminal, power and water supplies, dwellings, etc.) are being reviewed in the framework of an inter-district territorial scheme elaborated under the aegis of the Prefect of the Meuse District, acting as the co-ordinator Prefect of the project.

5. Industrial Issues

ANDRA has set an industrial structure for the CIGÉO project development.

The Cigéo shall be a non-typical nuclear installation designed to be built and operated for more than 100 years. Due to that long timescale, the decision was made to develop the repository structures by successive operating steps. The structures achieved in the framework of the CIGÉO's first phase shall include pilot structures.

Subject to approval, the purpose of the first construction phase shall be to ensure the disposal of the first waste packages by 2025. In its capacity as implementer and future operator, ANDRA shall ensure a strict technical control of the project throughout its existence. The Agency has reinforced its engineering skills (project management, design and handling of disposal packages, infrastructure engineering, economic assessment), by creating a specific division for engineering and managing the CIGÉO Project, with a view to ensuring the operational follow-up of subcontracts on studies. ANDRA is also developing its skills in the field of underground operations with the internalisation of that activity at the Bure Laboratory. Following the example of ANDRA's Scientific Board, the purpose of the Industrial Committee is to advise the Board of Administrators on industrial choices and to assess the activities of the services involved.

6. Other issues

While long-term safety was at the basis of the feasibility studies performed since the early 90s, operational safety is becoming now a priority. If the operational safety of CIGÉO, in its principle, is comparable with the safety of other existing nuclear facilities, the underground part of the facility includes non-typical characteristics that prevent from a direct transposition of more common practices. Underground installations have no equivalent compared to existing nuclear facilities in terms of volumes, and the underground environment limits accessibility. Managing the co-activity between underground work and nuclear operations must ensure the best worksite separation possible. With regard to fire-risk management, a dedicated regulation framework base line has been established, due to the specificities of the project. Significant work was also achieved in order to mitigate the risks associated with packages (reliability of engines, reduction of potential heights of fall, etc.).

According to the Safety Guide, *"once the disposal facility is closed, the protection of human health and of the environment shall neither depend on monitoring nor on institutional control that*

may not be ensured reliably beyond a limited period of time". That implies a sound understanding of the evolution of the repository (status of knowledge and of uncertainty levels) in order to make the repository as robust as possible against internal events (component failures) and external events (human intrusions, natural events) likely to occur over timescales exceeding 1,000 years. Every design evolution is therefore checked to make sure it has no significant impact on the long term hydraulic and transport performances of the disposal.

The design studies include a description of the disposal at closure. This gives a framework for simulations and long term safety assessment. ANDRA already implements a study and test program on seals, although these components will be implemented in several decades, for the closure phases. These studies may not prevent future evolutions of the repository design within an iterative optimisation process coupled with the periodic safety reassessments.

The 2006 Act also states that the reversibility of the disposal process should be granted, as a precaution, for at least 100 years, but without prescribing the actual reversibility conditions of the repository. Those conditions shall be set forth by a new act that shall be voted, after the review of ANDRA's application and before the authorisation to issue the creation-licence for the repository through a decree to be issued by the State Council after the public inquiry.

7. Conclusion

The Cigéo Project has moved to an industrial project. In order to ensure its success, it must consider multiple issues associated with local insertion, industrial planning, safety and reversibility, while controlling costs. ANDRA, as the implementer of the project, acts as the guarantor for the search of a fair equilibrium among all those concerns. The project needs open governance with clear responsibilities for each actor. The different entities for consulting or involving the relevant stakeholders allow them to express their views. In its capacity as implementer and future operator, ANDRA is responsible for final choices, with important decisions pertaining to the French Government.

The public debate in 2013 will address topics of interest to the public, including risk management, reversibility and retrievability, local development, monitoring of the environment. ANDRA will consider the results of the public debate to draw the final options for the design of the repository and the project, including its integration in the local development project. The license application to be submitted in 2105 will take account of the feedback from the public debate

Nuclear Data issues in the calculation of C14 and Cl36 in irradiated graphite.

DR ROBERT W. MILLS, ZAHID RIAZ

*Nuclear and Reactor Physics Team, UK National Nuclear Laboratory
B170, Sellafield, Seascale, Cumbria, CA20 1PG - UK*

PROF. ANTHONY W. BANFORD

*Waste Management & Decommissioning, UK National Nuclear Laboratory
5th Floor, Chadwick House, Warrington Road, Birchwood Park, Warrington WA3 6AE – UK*

ABSTRACT

Irradiated graphite from UK Magnox reactors represents about 30% of the UK intermediate waste inventory (estimated to be 80,000 m³ of graphite weighing approximately 130,000 metric tonnes) with similar graphite moderated reactors requiring decommissioning in France, Italy, Japan and Russia. Carbon-14 and chlorine-36 are both long-lived radionuclides that are produced in the graphite during irradiation and important for safety studies of geological disposal.

This work first considers the nuclear data issues and reviews the available evaluations and the related modelling issue of resonance self-shielding. Secondly, we compare some publically available measurements of irradiated Magnox graphite samples with calculations using MCNPX and FISPIN to estimate the achievable modelling accuracy. Finally a calculation is carried out for a whole Magnox core including the radial and axial reflector regions to estimate both the total and spatial distribution of important activation products.

1. Introduction

Irradiated graphite from UK Magnox reactors represents about 30% of the UK intermediate waste inventory (estimated to be 80,000 m³ of graphite weighing approximately 130,000 metric tonnes) with similar large scale graphite moderated reactors requiring decommissioning in France, Italy, Japan and Russia, and with many other smaller research reactors throughout Europe and the rest of the world [1]. The irradiated graphite in these cores include many activation products including ¹⁴C and ³⁶Cl, which are long-lived radionuclides that due to their chemical nature could possibly escape from geological repositories into the environment over tens of thousands of years and potentially contribute to public radiation doses.

As irradiated graphite wastes exists in many European Community member states, the CARBOWASTE project was instigated to examine the issues of managing these materials. The stated overall project aim is “The development of best practices in the retrieval, treatment and disposal of irradiated graphite (i-graphite) including other carbonaceous waste like structural material made of graphite or non-graphitised carbon bricks and fuel coatings (pyrocarbon, silicon carbide).” [2]

The achievement of this overall aim requires safety cases to be produced with a knowledge of the radiation doses given to workers and the general public from retrieving the i-graphite, its handling, storage, processing and, if appropriate, its final geological disposal. These doses are a direct result of the radionuclides present in the irradiated graphite and associated materials and structures either through external exposure to penetrating radiations such as gamma-rays and neutrons, or from skin contamination and ingestion of radionuclides released from the graphite and producing gamma-rays, x-rays, neutrons, electrons, positrons, fission fragments or alpha particles within the body. Thus an important starting point for such work is having a good estimate of the radionuclide inventory of the graphite and any integral components. However, these radionuclides cannot be accurately measured without expensive destructive analysis, thus using a combination of reactor

physics and activation modelling appears to be the most practical approach to estimate these inventories before commencement of decommissioning and thus allow a preliminary assessment of different waste management strategies.

The radionuclide inventory will be composed of four components: activation of chemical elements present in the graphite at manufacture which remain fixed in the graphite, activation of chemical elements present in the graphite at manufacture but which are released from the graphite and either deposited on other materials in the core or released to the environment during reactor operations, activation of chemical elements present in other reactor components which are carried on to the surface of the graphite by the coolant, and fission products and heavy elements that have escaped from the fuel and been carried principally on to the surface of the graphite by the coolant but may also penetrate the porous graphite. As the movement of radionuclides around the core and from failed fuel is a probabilistic process it is not beneficial to consider these effects at this stage and thus this report studies only the activation from elements present in the graphite at manufacture and does not model movement of radionuclides within the core.

The accuracy of such modelling depends upon understanding three factors; the initial composition of the materials (including impurities) and any changes during operation (e.g. graphite oxidation), the changing neutron flux, and its spectra, that the materials are exposed to during reactor operation and the nuclear data describing the neutron induced activation producing and destroying these radionuclides.

This study examines the accuracy of activation calculations for graphite in Magnox reactors considering the underpinning nuclear data and reactor physics, although many of its conclusions could inform work for other graphite moderated and gas cooled reactors. Also some nuclear data issues found in modelling codes during this work will affect the activation calculated within carbon bearing wastes from other reactor types.

This work first considers the nuclear data issues. The principal production routes of these nuclides in thermal neutron spectra are well known, but for some nuclides there are few measurements in epi-thermal, resonance and fast neutron spectra. The available nuclear data measurements and evaluations available for these principal production routes are reviewed including the recent JEFF, EAF and TENDL evaluations.

Secondly, following from this nuclear data review, calculations of these nuclides are compared with the only publicly available measurements of these nuclides in irradiated graphite from commercial reactors; two graphite samples irradiated in the Oldbury Magnox reactor and two irradiated in the Wylfa Magnox reactor. These calculations were carried out using MCNPX to calculate the neutron flux and its changes during reactor operation and then FISPIN to calculate the activation induced by these neutron fluxes in the graphite.

Finally, the MCNPX/FISPIN calculation route is used to model the variation of the neutron flux and spectra for a whole Magnox reactor core using the NNL GEMSTONE high performance computer cluster. This modelling, for the first time, gives sufficient accuracy on the neutron flux spectra outside the thermal neutron energy region to study the variation of reaction rates throughout the core and the results give new conclusions on how these two radionuclides will be distributed within the core graphite.

2. Nuclear Data Issues

The main three activation cross-sections leading to ^{14}C in thermal reactors are $^{14}\text{N}(n,p)^{14}\text{C}$, $^{17}\text{O}(n,\alpha)^{14}\text{C}$ and $^{13}\text{C}(n,\gamma)^{14}\text{C}$, in addition within fuel some ^{14}C is formed as a light charged particle emission from fission. However, as in this initial study no coolant gas (CO_2) activation is considered and there is no oxygen impurity specified for graphite, and graphite contamination by fuel is very rare, only the ^{13}C and ^{14}N routes to ^{14}C are important. For ^{36}Cl , the principle production route is $^{35}\text{C}(n,\gamma)^{36}\text{C}$. As the accuracy of any calculation will be based upon these cross-sections it is necessary to study these cross-sections.

The standard 172-group cross-section data used in current NNL irradiated spent fuel calculations is the TRAIL database (DB.WIMS172.6A_S5) that is processed using reactor physics calculations of flux, from the WIMS code, into a 3-group form suitable for use in the FISPIN10 code, which solves the nuclide production and destruction equations [3,4,5]. Thus this dataset, frozen in 1997, was compared with more recent datasets including the latest JEFF-3.1 activation file (JEFF-3.1/A) produced in 2003 [6], the 2007 European Activation File (EAF-2007) [7], which for these reactions are identical, and the more recent TENDL-2011 [8]. In these activation calculations the thermal cross-section is most important and thus these datasets are also compared with the 2200 m/s (thermal value) form Mughabghab (2006) [9]. The comparisons are shown in Figures 1 to 2.

From Figure 1a it can be seen that for $^{14}\text{N}(n,p)^{14}\text{C}$, the JEFF-3.1/A (EAF-2007) agrees with the TRAIL data and the Mughabghab value. The CINDER data in MCNPX-2.6.0 however, is significantly larger and the TENDL-2011 (as downloaded as grouped data through JANIS [10]) appeared to have processing problems leading to a larger cross-section in the thermal region. The existing TRAIL data is thus considered fit for purpose.

Although ^{17}O activation is not considered in this study, from Figure 1b it can be seen that for the $^{17}\text{O}(n,\alpha)^{14}\text{C}$ reaction, the JEFF-3.1/A (EAF-2007) agrees with the TRAIL data and the Mughabghab value in the thermal region but shows significant differences above 10 eV. The CINDER data in MCNPX-2.6.0 shows differences above 100 keV from the other data and the TENDL-2011 (as downloaded as grouped data through JANIS [10]) appeared to have processing problems leading to a larger cross-section in the thermal region. The existing TRAIL data is thus considered fit for purpose although uncertainties remain above the thermal region.

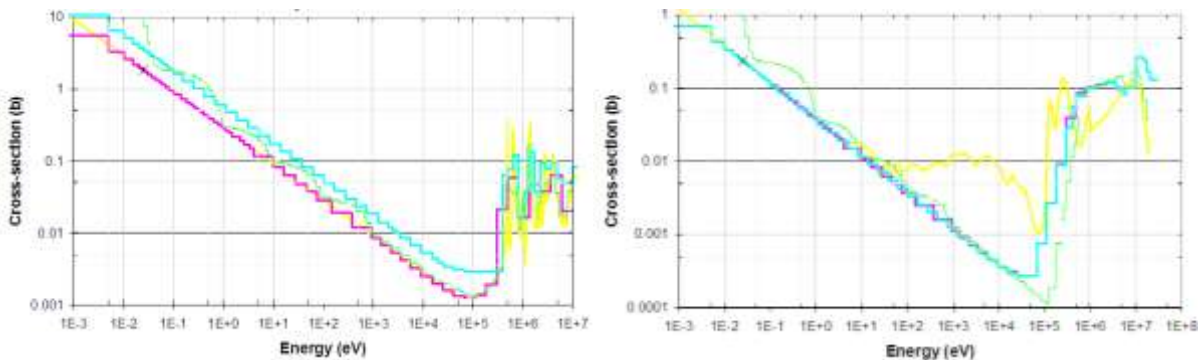

Figure 1 a) $^{14}\text{N}(n,p)^{14}\text{C}$ b) $^{17}\text{O}(n,\alpha)^{14}\text{C}$ cross-section. The JEFF-3.1/A continuous curve is given in yellow, the 172-group cross-sections from MCNPX-CINDER-2.6.0 are in light blue, TENDL-2011 in green and the TRAIL DB.WIMS172.6A_S5 in pink. The Mughabghab thermal value is given as a black cross.

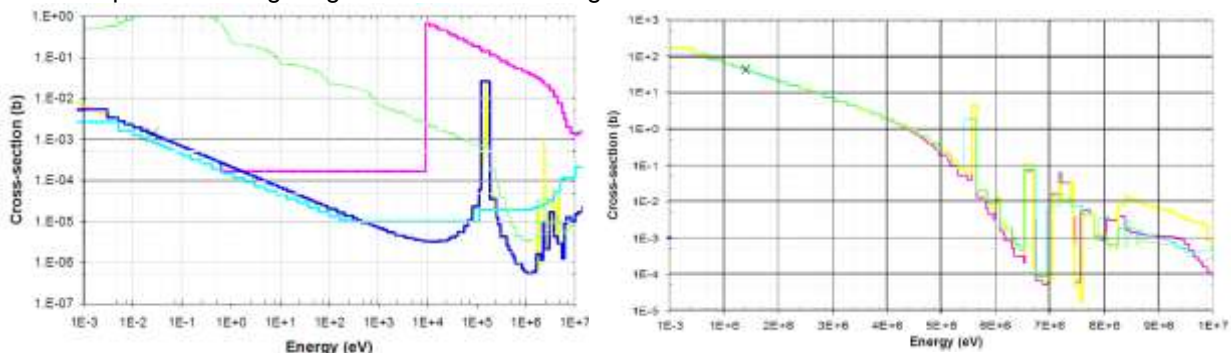

Figure 2a) $^{13}\text{C}(n,\gamma)^{14}\text{C}$ cross-section. 2b) $^{35}\text{Cl}(n,\gamma)^{36}\text{Cl}$ cross-section The JEFF-3.1/A continuous curve is given in yellow, the 172-group cross-sections from MCNPX-CINDER-2.6.0 are in light blue, TENDL-2011 in green and the TRAIL DB.WIMS172.6A_S5 in pink. The Mughabghab thermal value is given as a black cross. The dark blue curve represents revised TRAIL data based on JEFF-3.1/A described in the text.

As can be seen in Figure 2a, the standard TRAIL $^{13}\text{C}(n,\gamma)^{14}\text{C}$ cross-section is considerably different to the JEFF-3.1/ (EAF2007) values and values used in the MCNPX version 2.6.0 CINDER routine. The TRAIL cross-section for this nuclide was produced in the 1980's using empirical models by Smith and Deadman based upon the known cross-sections of nearby nuclides [11], a method which, at best, is only accurate to several orders of magnitude. An investigation showed that papers by Moxom and Raman [12,13] reported analyses of natural carbon and ^{12}C measurements to infer information on ^{13}C . Subsequently there was a measurement at 25.7 and 61.1 keV [14]. This was included with optical model calculations using the SIG-ECN code and the well-known thermal value [9], in an evaluation by Kopecky [15] that is used in the EAF-2003 and EAF-2007 files. Although there is not an accurate measurement of the $^{13}\text{C}(n,\gamma)^{14}\text{C}$ cross-section in the resonance region it was considered that the limited experimental data agreed with the new JEFF-3.1/A (EAF based) evaluations and the Mughabghab thermal value and this represents the best estimate of this cross-section at this time. A TRAIL database DB.WIMS172.6A_S6 was produced with the $^{13}\text{C}(n,\gamma)^{14}\text{C}$ activation cross-section replaced by the JEFF-3.1/A data for this work. It is recommended that consideration be given to new measurements for this reaction to better estimate this important ^{14}C production route.

From Figure 2b it can be seen that for $^{35}\text{Cl}(n,\gamma)^{36}\text{Cl}$, all the cross-section datasets are in good agreement up to 100 keV after which differences begin to appear. However, due to the high thermal cross-section these effects are insignificant for this work and the existing TRAIL data is considered fit for purpose.

The above comparisons were shared with the MCNPX development team and it is understood that considerably improved data has been prepared for CINDER which will be included in MCNPX at a later release. Similarly, the TENDL development team have addressed the issues on interpolation laws and normalisation and an improved file will be issued in December 2012.

3. Self-shielding effects in graphite

Given the strong resonances that appear in the new JEFF-3.1/A data for the ^{13}C capture reaction it was felt that the effect of resonance self-shielding should be considered. As no full ^{13}C evaluations exist for neutron transport codes it was not possible to do a complete resonance self-shielding calculation, but given that the effect is governed by the loss of neutrons of the resonance energy it is possible to calculate a self-shielding effect (proportional to the flux reduction) by simply considering the ^{13}C number density, the $^{13}\text{C}(n,\gamma)^{14}\text{C}$ cross-section from JEFF-3.1/A and the depth of graphite through which the neutrons travel. This ignores neutron scattering, but as this would reduce the effect it gives a maximum result. This study showed only a very slight reduction in flux from 1 eV to 10 MeV. The strongest effect appears between 150 and 200 keV. Figure 3 shows this reduction for different thicknesses of graphite. As the separation of Magnox rods is ~20 cm, it would thus be expected that this effect is less than 0.1%, and thus can be ignored in this work.

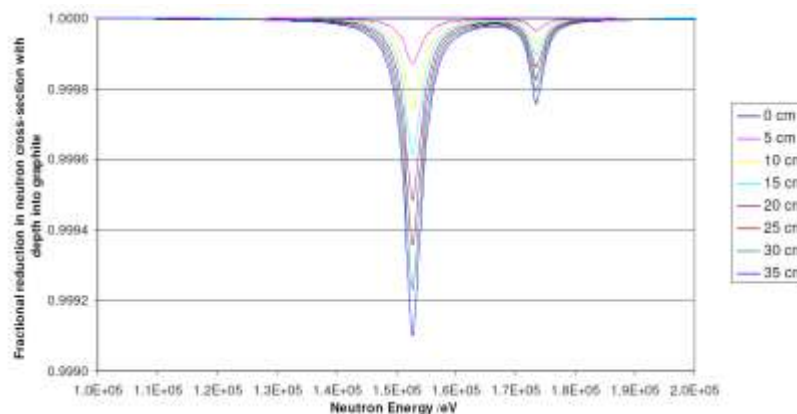

Figure 3 Reduction in effective ^{13}C capture cross-section over 100 to 200keV.

4. Graphite impurities

Nuclear graphite is manufactured from petroleum or pitch coke, the cokes usually being by-products of either the petroleum and or the coal industry. After production, the cokes are purified of volatiles by high temperature calcination. The calcined coke is then graded and mixed with a suitable pitch binder. Following forming and baking, the blocks are graphitised at 3000°C and then purified to remove metallic impurities as volatile chlorides in the presence of chlorine or freons until the neutron absorption of the solid is low enough for use in a reactor. This leads to a product with a high variability of impurities, it is also uncertain in what chemical form and where in the matrix these impurities exist. The impurities used in this work were values available in the Carbowaste project derived from UK heat certificate data for Pile Grade A graphite (PGA) [16]. Table 1 shows the values for the important impurities leading to ^3H , ^{14}C , ^{36}Cl and ^{60}Co .

Element	Wppm	Element	Wppm
Li	0.36	Fe	25
N	10	Co	<0.03
Cl	<2.0	Ni	6.0

Table 1 Graphite impurities for Magnox reactor PGA graphite in weight parts per million (wppm) [16]

5. Validation of Magnox graphite activation calculations

Currently the most practical method of justifying the accuracy of activation calculations is to benchmark calculations against experimental measurements. This study reports comparison between calculation and measurements of the activation products in four graphite samples to help justify the accuracy of such calculations for decommissioning purposes. The samples were installed within interstitial channels of the Wylfa and Oldbury reactors during their construction [16,17] and irradiated during the life of the reactors until their removal. The Oldbury 1 samples considered were withdrawn in August 2006 and the Wylfa 2 samples in April 2008. The samples are described in Table 2.

Sample	Reactor	Channel/ Set	Adjacent cumulative fuel Irradiation (MWd/t)	Comment
D3489/1	Oldbury R1	J09/569	29911	Enclosed sample
D3360/1	Oldbury R1	J09/568	38214	Vented sample
D3816	Wylfa R2	6620/827	38620	Sample with 0.2 mm skimmed from its surface before measurement to investigate effects of surface contamination.
D3810	Wylfa R2	6620/827	38620	Sample measured as received.

Table 2 Details of measured Magnox graphite samples considered in this work.

To calculate the activation of the samples in an inventory code, it is necessary to model the neutron flux and its energy spectra in the samples during the time the sample was within the reactor. The flux and its energy spectra will vary with reactor power, fuel burnup in the nearby channels, graphite weight loss and the periodic replacement of fuel elements. The neutron fluxes and their energy spectra within the four samples were calculated in this work using the MCNPX code (version 2.6.0) [18].

The MCNPX model consisted of a parallelepiped of carbon with reflective boundary conditions except for the top and bottom which were modelled as non-reflective boundaries. The model included the minimum unique repeating cell that represented the core. Within the model were four fuel channels, a control rod channel and an interstitial channel containing

the sample holder and the samples therein, see figure 4. The modelled geometries of the reactors and sample positions were taken from references supplied as a private communication [16]. It should be noted that the two reactors had different geometrical details and different positioning of the control rod and interstitial channels and thus required separate models.

In the MCNPX calculations burnup was modelled using the CINDER routine incorporated in the code. The models were irradiated at the reactor average power for a number of time steps until the reactor average discharge was achieved, then the fuel was replaced with fresh fuel and the irradiation continued. These refuelling cycles were repeated until the cumulative fuel irradiation adjacent (CFIA) to the samples were those associated with the samples. The graphite weight loss was estimated for each cycle using a linear falloff with CFIA between the reactor start-up (virgin graphite density, 1.732 g/cc [15]) and the final value measured from the samples (Oldbury ~1.4 g/cc and Wylfa ~1.5g/cc [17]). In this work the fuel was modelled as a single rod the active length of the string with the same uranium mass. Each burnup cycle was modelled as a number of short time steps allowing for the change of neutron flux resulting from the changes in the fuel composition during burnup [16]. Each refuelling cycle took 5 days of computation using 28 processors on the NNL Gemstone to get an accurate estimate of the flux in the full 172-groups.

The neutron flux spectra were tallied in the sample positions and using the 172-group TRAIL cross-section database, FISPIN cross-section libraries and input decks prepared to calculate the production and destruction of activation products based upon the supplied impurities [16], including cooling to the dates of the radionuclide measurements [17].

It should be noted that FISPIN has been cross-compared with other inventory codes and shown that it gives the same answers as other codes ($\pm 0.2\%$) if comparing calculations of the same case with the same nuclear data [19]. As part of this work comparisons were made using the standard NNL fuel inventory route with a 2D approach using WIMS/TRAIL/FISPIN, and when these results were compared to the MCNPX/FISPIN route the results were all well within the variation of C/E found for the samples, implying the new MCNPX method is acceptable.

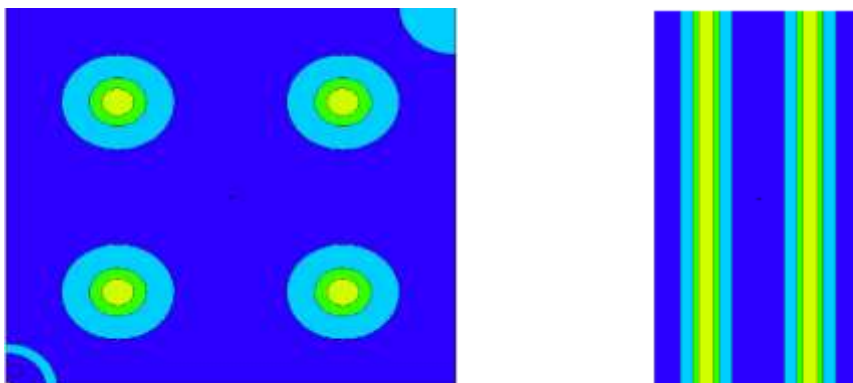

Figure 4: Diagram of the MCNPX model showing a) a horizontally slice half-way up the reactor core showing the 2 by 2 array of rods including the control rod and interstitial channel containing the graphite sample holder and sample and b) a vertical slice through showing two of the Magnox rods.

The results for the FISPIN calculations for the radionuclide activities of interest are shown in Table 3 to 5 with the experimental measurements [17]. As the Wylfa measurements concerned the same sample, before and after skimming, only one calculation was necessary. It should be noted that differences in measured activity from this sample, before and after skimming, may aid understanding of surface contamination being deposited from the coolant.

Given the small number of samples, the variability of the initial graphite impurity compositions and the uncertainties of how much of these are lost during the irradiation it is difficult to be

definitive as to the applicability of these results to a calculated inventory, but for this work all the ^{14}C calculated/experiment (C/E) results lie between 0.25 and 4.0. Of the other nuclides; ^{36}Cl is overestimated by 3 to 25 times, ^3H is overestimated by 3 to 80 times and ^{60}Co is 0.5 to 8 times, suggesting these nuclides will be probably be over-predicted in the subsequent FISPIN calculations. It should be remembered that these calculations do not include any estimation of the movement of active or inactive species, nor radionuclides from burst fuel cans or the activation of the coolant gas. It is thus most probable that the over-prediction results from a combination of the initial impurities estimate being too high and/or the impurities and activation products are being lost from the graphite during the reactor life.

nuclide	FISPIN	Activity per gram (Bq/g)	C/E \pm 2 SD
H 3	3.41E+06	1.25E+06 \pm 2.0E+05	2.73 \pm 0.44
C 14	9.07E+04	2.80E+05 \pm 4.4E+04	0.32 \pm 0.05
CL 36	5.45E+02	2.86E+01 \pm 3.9E+00	19.06 \pm 2.60
CO 60	5.83E+04	1.11E+04 \pm 8.1E+02	5.25 \pm 0.38

Table 3 Ratio of calculation over measured values for D3489/1

nuclide	FISPIN	Activity per gram (Bq/g)	C/E \pm 2 SD
H 3	3.43E+06	4.37E+04 \pm 1.3E+03	78.56 \pm 2.34
C 14	9.95E+04	3.78E+05 \pm 5.2E+04	0.26 \pm 0.04
CL 36	5.85E+02	2.30E+01 \pm 3.3E+00	25.44 \pm 3.65
CO 60	6.13E+04	8.18E+03 \pm 7.8E+02	7.50 \pm 0.72

Table 4 Ratio of calculation over measured values for D3360/1.

nuclide	FISPIN Activity per gram (Bq/g)	D3816 (skimmed) Activity per gram (Bq/g)	D3810 (as supplied) Activity per gram (Bq/g)	D3816 (0.2 mm skimmed from surface) C/E \pm 2 SD	D3810 (as supplied) C/E \pm 2 SD
H 3	3.74E+06	4.46E+05 \pm 1.3E+03	1.15E+06 \pm 8.6E+03	8.39 \pm 0.02	3.25 \pm 0.02
C 14	9.55E+04	7.35E+04 \pm 7.2E+03	2.72E+04 \pm 3.6E+03	1.30 \pm 0.13	3.51 \pm 0.46
CL 36	5.50E+02	1.81E+02 \pm 1.7E+01	7.29E+01 \pm 9.7E+00	3.04 \pm 0.29	7.54 \pm 1.00
CO 60	7.54E+04	6.21E+04 \pm 1.4E+03	1.52E+05 \pm 1.4E+04	1.21 \pm 0.03	0.50 \pm 0.05

Table 5 Ratio of calculation over measured values for samples D3816 and D3810.

Sample	D3489/1	D3360/1	D3816 (skimmed)	D3810
10 wppm N (S5)	C/E=19.92	C/E=15.87	C/E=76.98	C/E=208.02
10 wppm N (S6)	C/E=0.32	C/E=0.26	C/E=1.30	C/E=3.51
0 wppm N (S6)	C/E=0.24	C/E=0.20	C/E=0.98	C/E=2.65

Table 6 ^{14}C estimates using the old and new nuclear data and, with 0 and 10 wppm of nitrogen

A small sensitivity study was carried out for ^{14}C production considering the existing TRAIL database and using the improved $^{13}\text{C}(n,\gamma)^{14}\text{C}$ cross-section, and the initial nitrogen content. The results, in Table 6, shows that the corrected $^{13}\text{C}(n,\gamma)^{14}\text{C}$ cross-section massively reduces the ^{14}C over prediction and that at an impurity of 10 wppm nitrogen about two thirds of ^{14}C predicted by the calculation derives from the ^{13}C activation.

5. Whole Magnox core calculation

Following from the above calculations it was decided to model a whole core using the available data for the Oldbury 2 reactor, however the complexity of such a model and the time to get an accurately converged 172-group flux required the calculation to be carried out using a similar approach to the 2 by 2 fuel channel model. The new model included the power history for this reactor (see figure 5a), an improved model including the axial gaps between the fuel elements, tally regions of 5.1 cm height in the axial reflectors and 40.6 cm height in the fuelled region, a core radial power distribution typical of normal operation and a detailed estimate of the graphite weight loss variation these data being supplied in private communications (see figure 5b)[16]. As before the initial components of the graphite and

activation products were not assumed to move during the irradiation.

The MCNPX/FISPIN approach was repeated for each of the 52 axial regions in each channel being modelled in the central flattened zone and at four positions in the region towards the edge of the core where the power drops rapidly. In addition, the flux in the radial reflector region was approximated using a central cylindrical neutron source assumption with no neutron loss in the reflector, which as the neutron path length is of the order of the radial reflector thickness, was assumed an adequate approximation for this low activation region. The resultant activations of ^3H , ^{14}C , ^{36}Cl and ^{60}Co are given in figures 6a, 6b, 6c and 6d.

These show that at the end of life, the dominant activities will not be distributed evenly across the core. It is interesting to note that these calculations show the ^3H activity as almost flat across the core; this is a result of the almost complete burnout of its principle activation source, the ^6Li . This is shown in figure 7, along with the changes in the other important nuclides.

The calculations were then combined to give an estimate of the core average Bq/t of the important activities (including the reflector regions), these results are shown in Table 7 including estimates of the activity at 10, 100 and 1000 years after shutdown. To show the effect of nitrogen on these calculations the ^{14}C activity is shown assuming no nitrogen impurity in the graphite. This work suggest that around 65% of the ^{14}C is produced from the activation of the carbon within the graphite assuming a 10 weight part per million of nitrogen.

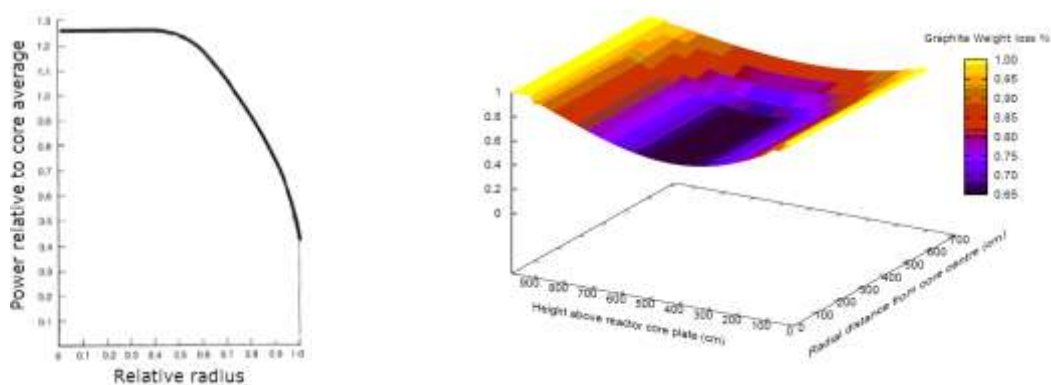

Figure 5a) Power distribution radially across the core 6 and 5b) Graphite weight loss shown radially and axially for Oldbury 2 at end of irradiation (6th March 2011).

6. Conclusions

This work has shown that it is possible to estimate the activation of structural materials in a whole core Magnox reactor using existing tools, but that there is very limited validation against experimental measurements to fully understand the chemical, physics and engineering aspects of this and ultimately justify safety cases related to irradiated graphite. This work has highlighted the dangers of using codes and their data developed and tested for one purpose (e.g. the well established practice of calculating spent fuel inventory) for other purposes (e.g. activation of Magnox core graphite) which are sensitive to different nuclear data, physical processes and modelling assumptions. It is considered important that more measurements are made of irradiated Magnox graphite and compared with code calculations before these calculations can be used to justify safety case studies.

7. Acknowledgements

The authors would like to thank the European Commission and the UK Nuclear Decommissioning Authority (NDA) for funding this work as part of the EURATOM FP7 Carbowaste project. We would also like to thank the NDA for releasing the measurements of irradiated graphite [18] that forms the basis of this work. In addition, we would like to thank the following people for their help and advice; Martin Metcalfe (NNL), Ian Cain (formerly of Magnox Ltd), Richard Jarvis (NNL) and Paul Little (NNL) for their assistance during this work.

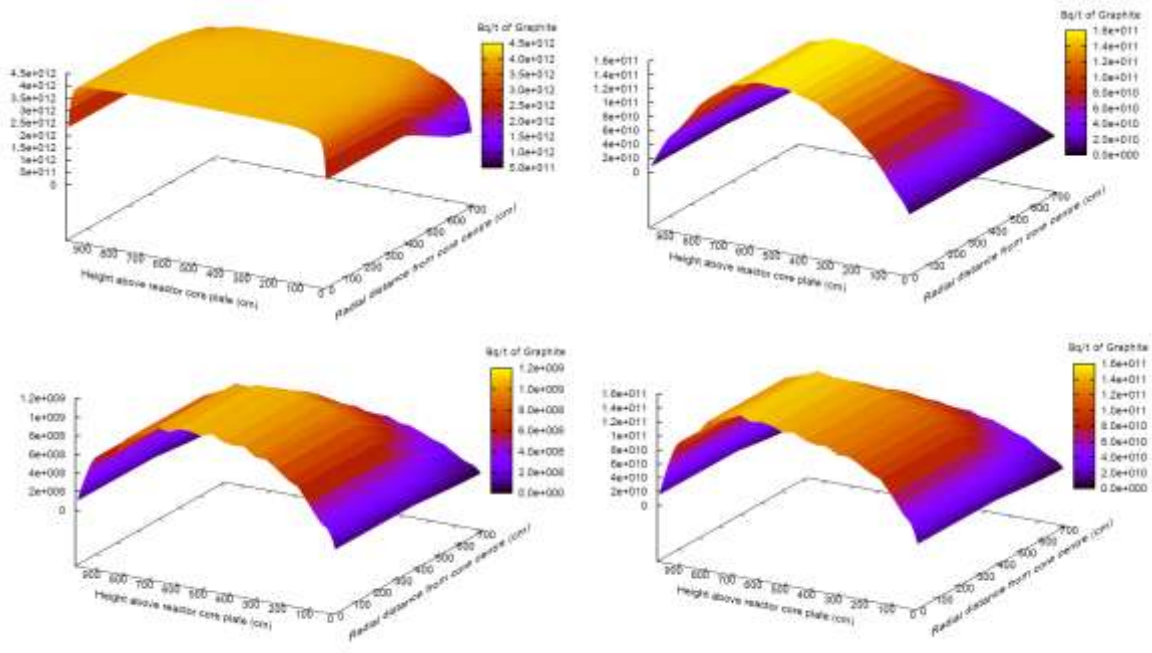

Figure 6 ^3H , ^{14}C , ^{36}Cl and ^{60}Co activity distributions (top left, top right, bottom left, bottom right) plotted against axial height and radial distance within the core.

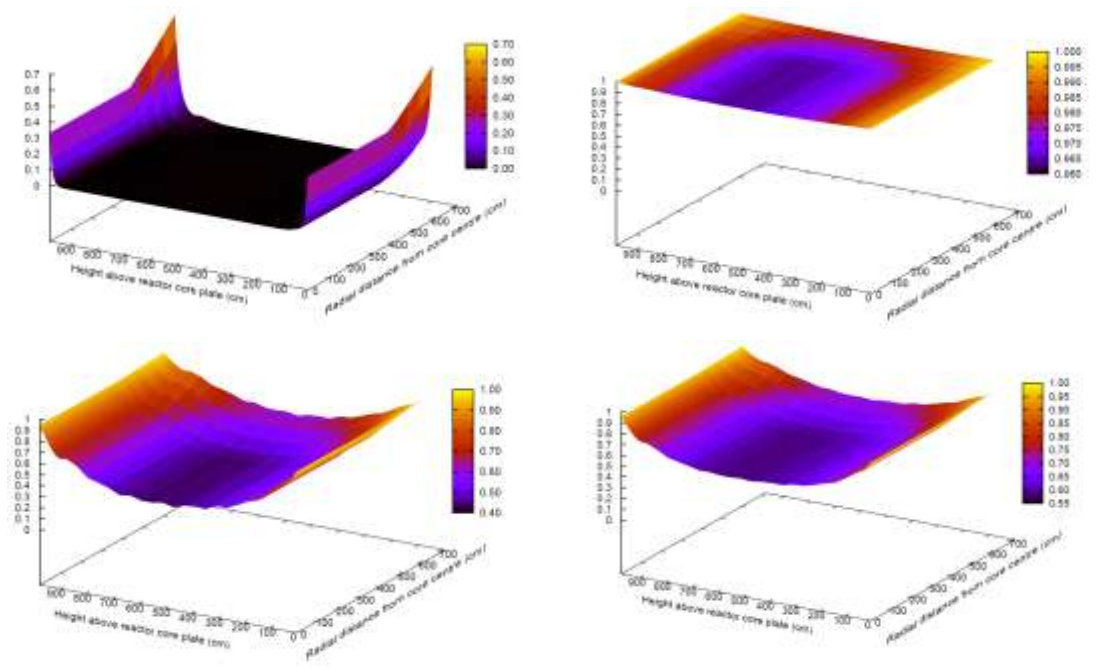

Figure 7 ^6Li , ^{15}N , ^{35}Cl and ^{59}Co fractional amount present at the end of life compared to the initial concentrations (top left, top right, bottom left, bottom right) plotted against axial height and radial distance within the core. ^{12}C and ^{13}C are not shown as these changed by less than 1%.

Nuclide	Mean graphite activity estimate Bq/t			
	6 th March 2011	Cooled for 10 years	Cooled to 100 years	Cooled to 1000 years
H 3	3.7E12	2.11E+12	1.3E+10	-
C 14	7.8E10	7.8E+10	7.7E+10	6.9E+10
C 14 (no N)	5.0E10	5.0E10	4.9E10	4.4E10
Cl 36	6.2E8	6.2E+08	6.2E+08	6.19E+08
Co 60	8.6E10	2.3E+10	1.7E+05	-

Table 7 Core averaged graphite activity per tonne of initial graphite at the end of the available reactor power history and then subsequently cooled for 10, 100 and 1000 years.

7. References

1. "CARBOWASTE - An Integrated Approach to Irradiated Graphite", A.W. Banford, H. Eccles, M.J. Grave, W. von Lensa, S. Norris, Nuclear Future; Volume 04, Issue 05; September/October 2008; ISSN 1745-2058
2. "Treatment and disposal of irradiated graphite and other carbonaceous waste", W. von Lensa, D. Vulpius, H. J. Steinmetz, N. Girke, D. Bosbach, B. Thomauske, A. W. Banford et al. (2011). ATW-Internationale Zeitschrift für Kernenergie, 56(4), 263.
3. "The ANSWERS Software Package WIMS: A modular code for neutronics calculations User Guide", Report ANSWERS/WIMS(99)9, published by AEA Technology (1999).
4. "User's Manual: Program TRAIL", Report ANSWERS/TRAIL/MQ2, E.B. Webster, published by AEA Technology (1996).
5. "FISPIN For Nuclide Inventory Calculations: Introductory Guide for Version 10", Report ANSWERS/FISPIN/REPORT/001 published by Serco Assurance Ltd (2007).
6. "The JEFF-3.1 Nuclear Data Library", JEFF Report 21, issued by the Nuclear Energy Agency ISBN 92-64-02314-3 (2006)
7. "The European Activation File: EAF-2003 Cross section Library", Report UKAEA FUS 486 by R. A. Forrest, J. Kopecky and J-Ch Sublet. and "The European Activation File: EAF-2007 Cross section Library", Report UKAEA FUS 535 by R. A. Forrest, J. Kopecky and J-Ch Sublet.
8. "TENDL-2011: TALYS-based Evaluated Nuclear Data Library", A.J. Koning and D. Rochman, Nuclear Research and Consultancy Group (NRG), Petten, The Netherlands (2011). See <ftp://ftp.nrg.eu/pub/www/talys/tendl2011/tendl2011.html>
9. "Atlas of Neutron Resonances", Book, Elsevier, ISBN13 978-0-444-52035-7, S.F. Mughabghab (2006).
10. "Recent Upgrades to the Nuclear Data Tool JANIS", N. Soppera, M. Bossant, E. Dupont, H. Henriksson, and Y. Rugama: Proceedings of the International Conference on Nuclear Data for Science and Technology 2010, April 26-30, 2010, Jeju Island, Korea
11. "A procedure for the automated production of libraries of burn-up dependent actinide and fission product cross-sections for use with the FISPIN code", UKAEA paper IMAC/P(87)161, R.W. Smith and K. Deadman (1986).
12. Moxon, M.C., Bond, D.S., Brisland, J.B.: Proc. Int. Conf. on the Physics of Reactors, Marseille, 1990, Vol. 1, part 3, p. 32.
13. "Valence capture mechanism in resonance neutron capture by ^{13}C ", S. Raman, M. Igashira, Y. Dozono, H. Kitazawa, M. Mizumoto, J. E. Lynn, Phys. Rev. C 41, 458–471 (1990).
14. "Measurement of the $^{13}\text{C}(n,\gamma)^{14}\text{C}$ cross section at stellar energies", T. Shimaa, F. Okazakia, T. Kikuchia, T. Kobayashia, T. Kiia, T. Babaa, Y. Nagaia and M. Igashirab, Nuclear Physics A621, 231c-234c (1997).
15. "Atlas of Neutron Capture Cross-sections", prepared by J. Kopecky, IAEA report INDC(NDS)-362 (1997).
16. Private communications from Martin Metcalfe, UK Nation Nuclear Laboratory and for Oldbury power histories, Ian Cain, Magnox Ltd.
17. "MCNPX Users Manual, Version 2.6.0", Denise B. Pelowitz (2008)
18. NNL (09) 10465 "Test Report: Radionuclide Fingerprinting of Wylfa and Oldbury Graphite Samples", J A Caborn and A Twist, November 2009. Released by NDA under Unique Reference 500020806/Amanda French.
19. B.F. Duchemin, C. Nordborg, "Decay Heat Calculation- An international nuclear code comparison", NEA report NEACRP- 319 "L" (1989).

GEOLOGICAL DISPOSAL OF UK HIGHER ACTIVITY WASTES – UNDERPINNING SCIENCE AND TECHNOLOGY

NEIL SMART

NDA, Herdus House, Westlakes Science Park, Moor Row, Cumbria, CA24 3HU

ABSTRACT

Geological disposal is the UK Government's policy for the management of higher-activity radioactive wastes. The principle of geological disposal is to isolate the waste deep inside a suitable rock formation to ensure that no harmful quantities of radioactivity reach the surface environment. To achieve this, the waste will be placed in an engineered underground containment facility – the geological disposal facility (GDF). The facility will be designed so that natural and man-made barriers work together to minimise the escape of radioactivity. The Nuclear Decommissioning Authority (NDA) has responsibility for the implementation of geological disposal in the UK. NDA has set up the Radioactive Waste Management Directorate (RWMD) to develop an effective delivery organisation to implement a safe, sustainable and publicly acceptable geological disposal programme. RWMD has developed multi-barrier concepts for geological disposal of higher-activity radioactive wastes. These wastes include high-level waste (HLW), spent nuclear fuel, intermediate-level (ILW) and certain low-level (LLW) radioactive wastes.

The safe implementation of geological disposal must be underpinned by a sound science. This paper describes the approaches taken by RWMD to build confidence in the scientific basis for geological disposal in the UK.

It describes a four-step process for developing the science base to support the safety arguments for geological disposal:

- Setting out the evidence base on which those arguments are based;
- Identifying those areas where the science base requires further development;
- Carrying out R&D to fill those information gaps; and
- Re-evaluating the evidence.

It also describes the processes used to ensure quality of the scientific evidence base as the programme develops.

1. Introduction

UK Government policy published in the 2008 *Managing Radioactive Waste Safely* (MRWS) White Paper [1] identified the Nuclear Decommissioning Authority (NDA) as the organisation responsible for implementing geological disposal of the UK's higher activity radioactive waste. The NDA established its Radioactive Waste Management Directorate (RWMD) to act as its delivery organisation for geological disposal for higher activity wastes.

Since December 2009 RWMD has been operating as a prospective site licence company (SLC). This means putting in place the organisational arrangements and management systems that are necessary to be capable of holding environmental permits and a nuclear site licence when the programme reaches that stage.

The higher activity wastes to be managed in the long-term through geological disposal are set out in the MRWS White Paper [1].¹ They comprise all radioactive material that has no further use and that cannot be managed under the *Policy for the Long-term Management of Solid Low Level Radioactive Waste in the United Kingdom* [2] through, for example, emplacement in the low-level waste repository (LLWR). These higher activity wastes include:

- **high-level waste (HLW)** – a liquid by-product from the reprocessing of spent nuclear fuel, which is made passively safe by converting it to a solid glass wasteform through a process known as vitrification. HLW generates significant heat, which has to be taken into account in designing storage or disposal facilities;
- **intermediate-level waste (ILW)** – arising mainly from the reprocessing of spent fuel and from general operations, maintenance and decommissioning at nuclear sites, and including metal items such as fuel cladding, reactor components, and sludges from the treatment of radioactive liquid effluents; and
- **a small fraction of low-level waste (LLW)** – unsuitable for near-surface disposal in the LLWR.

In addition to these wastes, there are some radioactive materials that are not currently classified as waste. These may, if it were decided at some point that they had no further use, need to be managed through geological disposal. These materials include:

- spent fuel (SF);
- plutonium; and
- uranium.

Government will decide, in conjunction with the waste owners, whether or not these materials should be declared as waste in the future. In the meantime, the inclusion of these materials will be factored into the design and development of a geological disposal system.

Information on the quantities and types of UK radioactive waste and other materials potentially destined for geological disposal is periodically compiled to produce the UK Radioactive Waste Inventory (UKRWI). The UKRWI was last updated in 2007 and the next version is due for publication in early 2011 [3].

The total volume and types of radioactive waste are subject to a number of variables, including strategic decision-making on the management of materials not currently classified as waste, and on the approaches selected to package waste for disposal. The Baseline Inventory of higher activity radioactive wastes and other materials that could possibly come to be regarded as waste requiring management through geological disposal in the future is given in the MRWS Paper.

The most recent UKRWI does not include radioactive waste arising from proposed new nuclear build in the UK. The volume of such waste produced would depend on aspects such as the reactor type, how many new reactors there are and how long they operate. Government's view is that it would be technically possible to dispose of any waste arising from new nuclear build in a geological disposal facility. Through the generic design assessment process [4] the nuclear regulators are assessing the safety, security and environmental impact of power station designs, including the quantities and types of waste (gaseous, liquid and solid) that are likely to arise, their suitability for storage and their disposability [5]. RWMD has contributed to this process by assessing the disposability of wastes that may arise from new nuclear build.

The approach taken in developing RWMD's work programme reflects the uncertainty in types and total volumes of waste destined for disposal by considering a number of scenarios

¹ In Scotland, the policy for Higher Activity Waste is for '*long-term near surface, near site storage or disposal facilities so that the waste is monitorable and retrievable and the need for transporting it over long distances is minimal*'.

in its planning. In particular an upper inventory has been developed to give an indication of the quantities that might need disposal. This will enable RWMD to assess whether a geological disposal facility can be developed to deal with this inventory safely and securely in addition to a lesser inventory. The upper inventory also provides visibility to local communities that are considering participation in the MRWS site selection process of what might be involved in hosting a geological disposal facility.

As outlined in the MRWS White Paper, geological disposal will involve constructing an engineered facility underground, at a depth somewhere between 200 and 1000 metres, in which radioactive wastes can be placed and isolated from the surface environment [6]. An illustrative facility structure is shown in Figure 1. The NDA will keep alternative waste management options such as borehole disposal for certain types of waste under review.

Geological disposal concepts incorporate both engineered and natural barriers to prevent/limit radionuclide release, as part of a multi-barrier approach to isolating radioactive waste from the surface environment. This approach is the underlying principle behind most international concepts for HLW, SF and ILW disposal. The passively safe, solid wasteform, the waste containers, other engineered components of the facility such as a metal overpack (where included) and any buffer and/or backfill, and the surrounding geological environment all provide independent, yet cooperative barriers to the release of radionuclides. Together they work to help ensure that radionuclides are isolated from the environment for appropriately long times. A schematic representation of a multi-barrier concept is provided in Figure 2.

Figure 1 Schematic representation of a generic geological disposal facility

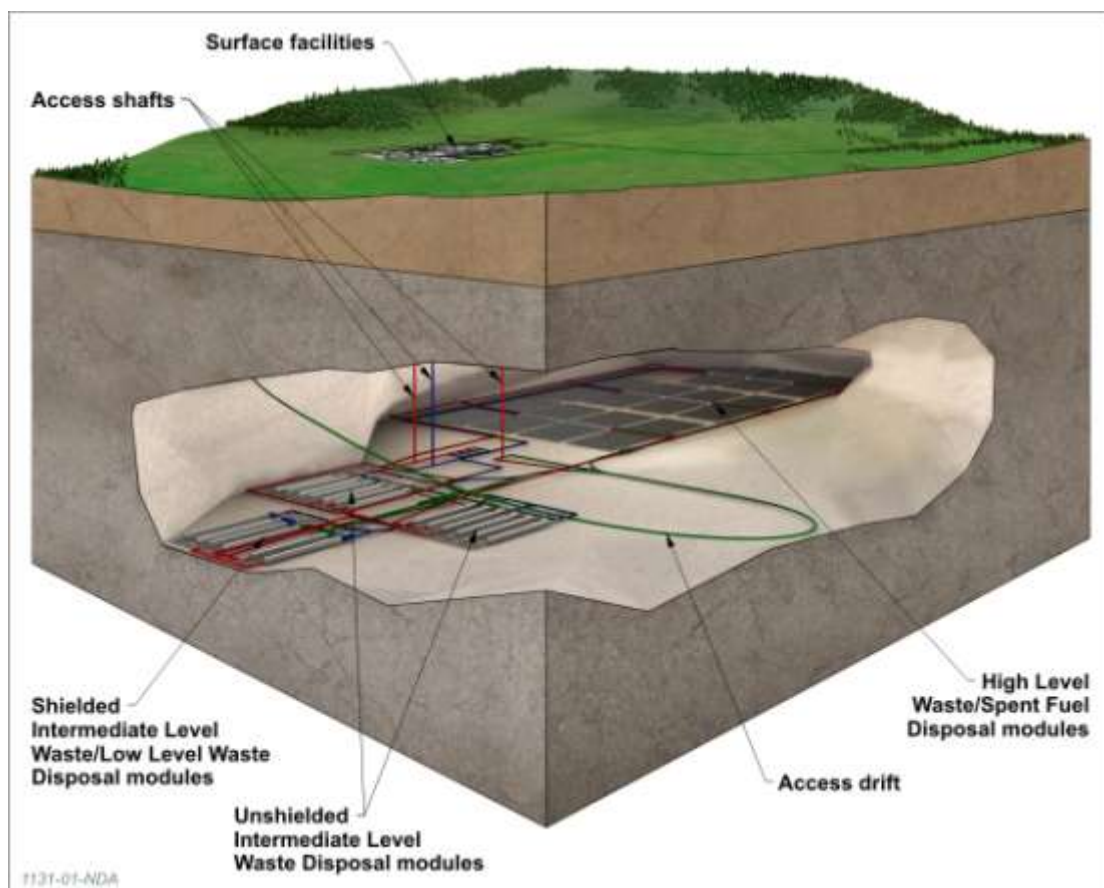
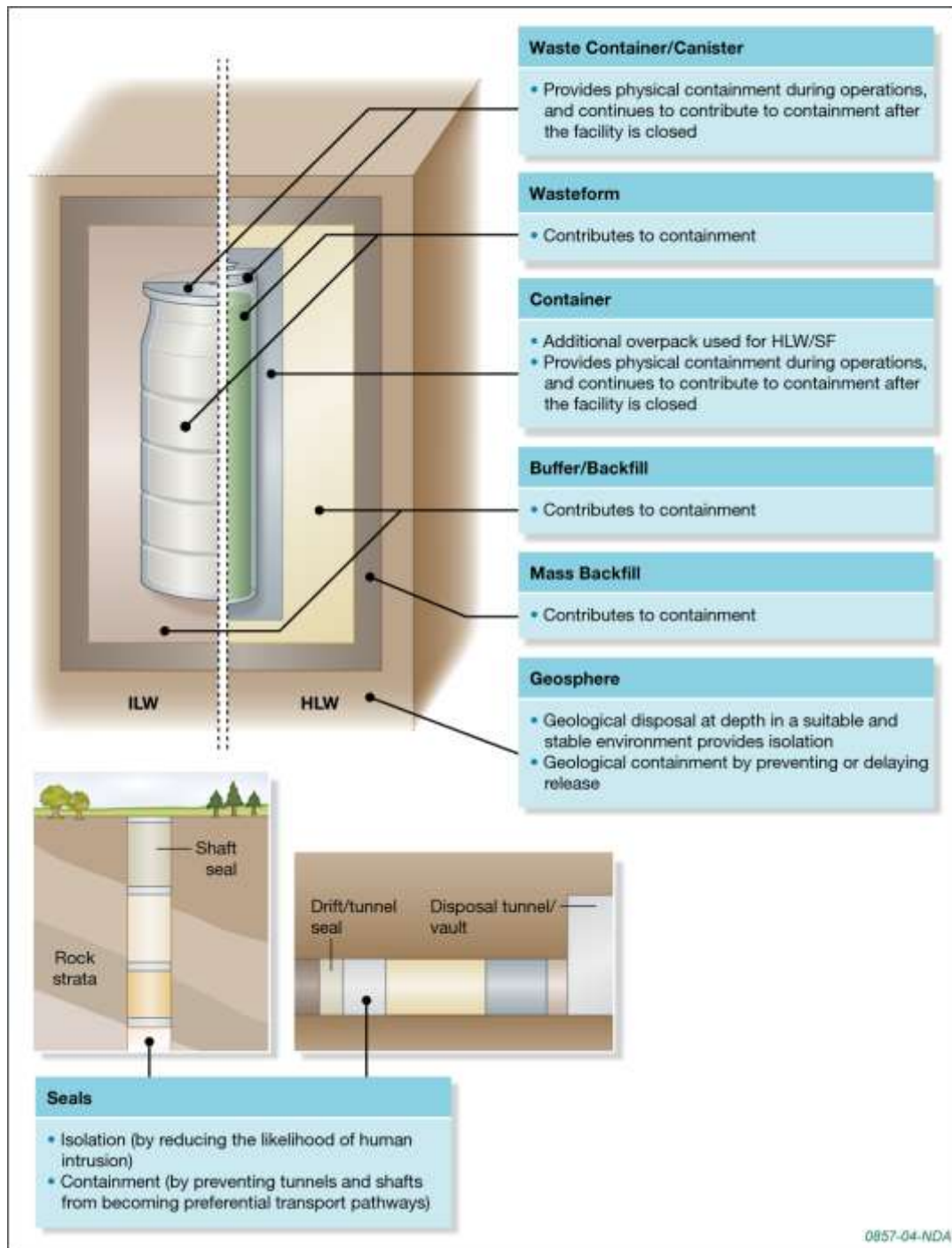

Figure 2 Schematic representation of the multi-barrier concept for geological disposal



The performance of different engineered barriers within a geological disposal facility is strongly dependent on the nature of the surrounding environment (for example, the geology and groundwater chemistry). The engineered facility will be designed so that its performance is optimised for the sub-surface conditions of the disposal site and wastes requiring disposal. Its design is therefore site-specific. The MRWS site selection process is currently in the early stages. Until a site (or sites) is selected, detailed design specifications and site-specific studies cannot be undertaken and studies are therefore non-site specific, and consider a wide range of disposal concepts.

2. Evidence base supporting safety of disposal

A key aspect of meeting all relevant regulatory requirements in the delivery of a geological disposal facility will be the development of a robust safety case to demonstrate that members of the employees, public and the environment are adequately protected both at the time of disposal and in the future. Until potential candidate sites are identified the development will focus on:

- developing the overall safety strategy - this includes the safe transport of waste to the disposal facility, the strategy for ensuring safe construction, operation and closure of the facility and the strategy for ensuring long-term safety through the use of a multi-barrier disposal system;
- understanding the safety and environmental implications of a range of multi-barrier disposal concepts that may be appropriate for geological disposal in the UK - these concepts include different approaches to the engineered barriers and the different geological settings which determine some aspects of the engineering design;
- identifying key technical challenges for making a safety case and explaining how RWMD has, or can, develop confidence that these challenges can be overcome; and
- developing a peer-reviewed, generic Disposal System Safety Case (DSSC) which presents approaches to the assessment of safety for a geological disposal facility in different geological settings - this is to provide a basis for the assessment of the safety of geological disposal at candidate sites.

The generic DSSC [7] explains what will be involved for a site-specific DSSC. It has been developed in such a way as to be capable of evolving into a full site-specific DSSC to support the necessary regulatory submissions for a geological disposal facility. The generic DSSC thus provides a demonstration of how the safety case will eventually be made, and it has been presented to the regulators on that basis.

The safety case will be updated as knowledge of the site increases in line with the development of a disposal facility and at suitable intervals during the period of authorisation. Updates will reflect the growing knowledge about the site and the disposal facility.

It is anticipated that the early stages of the site characterisation will focus on building a conceptual geoscientific understanding of the site to allow the selection of the specific engineering design and associated approaches within the safety case. Later stages of the site characterisation will then aim to meet the specific data and information requirements of the safety case and engineering design.

3. Areas requiring further development

The RWMD technical programme is needs-driven, with the objective of meeting the specific requirements of the disposal system specification (DSS), engineering design, safety case development and environmental assessment activities necessary to implement a geological disposal system in the UK and support waste producers to implement their programmes. The programme is built on extensive background information and the work is delivered through an “iterative development process”, which ensures that all activities are integrated across the organisation and that knowledge gained is captured into the corporate memory via updating the technical baseline. These processes are described in more detail below.

During the early phases of the MRWS site selection process (see Figure 3), the technical programme will be driven by acquiring information and data aligned to generic requirements and using this in the formulation of knowledge for progression of the programme. A consequence of this is that a significant proportion of the work is aligned to understanding the wastes in the context of the potential disposal environments and preparing for surface based investigations (during MRWS stage 5). As the understanding of sites is developed

during stage 5, this will enable selection of preferred concepts and designs for potential sites. As the programme matures and understanding of the geological environment(s) is available, the work will move towards site specific designs, site specific safety cases etc.

In stage 6 of the MRWS site selection process, it is expected that work will focus on optimisation of a transport system design and the design, operation, closure and post-closure safety of a GDF for the given site and inventory in terms of overall radiological protection.

Further information on the approach to optioneering studies during development of a GDF is available [8].

Figure 3 The stages in the MRWS Site Selection Process

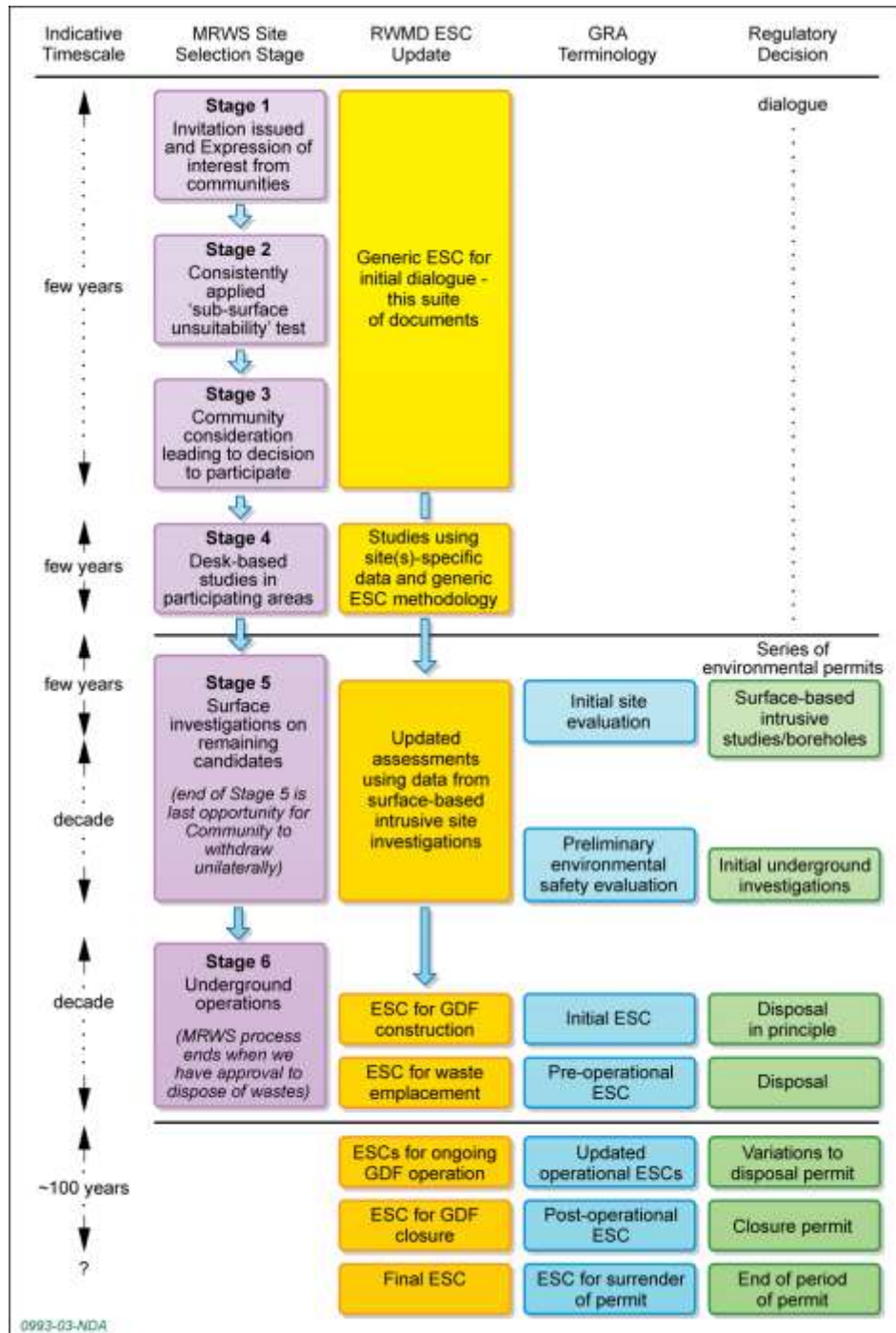

The technical work is planned to focus effort where it is most critical to the successful delivery of the geological disposal project and to maximise the benefit to the programme of the outputs delivered. To do this, RWMD need to know what knowledge is needed to support forthcoming decisions, and where technical work has already delivered results.

The MRWS site selection process is a key driver for the work programmes. However, a number of the activities are generic and therefore not directly linked to the MRWS site selection process. Technical work will be required to support NDA strategy and waste producers requirements throughout the MRWS site selection process.

4. Carrying out R&D to fill knowledge gaps

RWMD has an overall strategic approach to the process for identification and delivery of the technical work programme:

- The programme is framed by a number of external requirements / inputs, including the inventory, the MRWS White paper, regulatory requirements, stakeholder views and interactions with the broader nuclear industry with respect to the lifecycle for radioactive waste management.
- The framework provides a basis from which the drivers for the work programmes are identified.
- The information needed to meet the drivers are collated, prioritised and scheduled resulting in the development of the RWMD technical plan. The approach to the work to be undertaken is guided by the strategic activities illustrated in Figure 4.
- Work programmes are then delivered within a project management framework. A significant amount of work is commissioned externally from organisations with expertise in the relevant fields.
- The outputs from work programmes are reviewed and any changes considered through updating of the technical baseline. The overall process is illustrated below:

Figure 4 Overall process for identification and delivery of the technical strategy

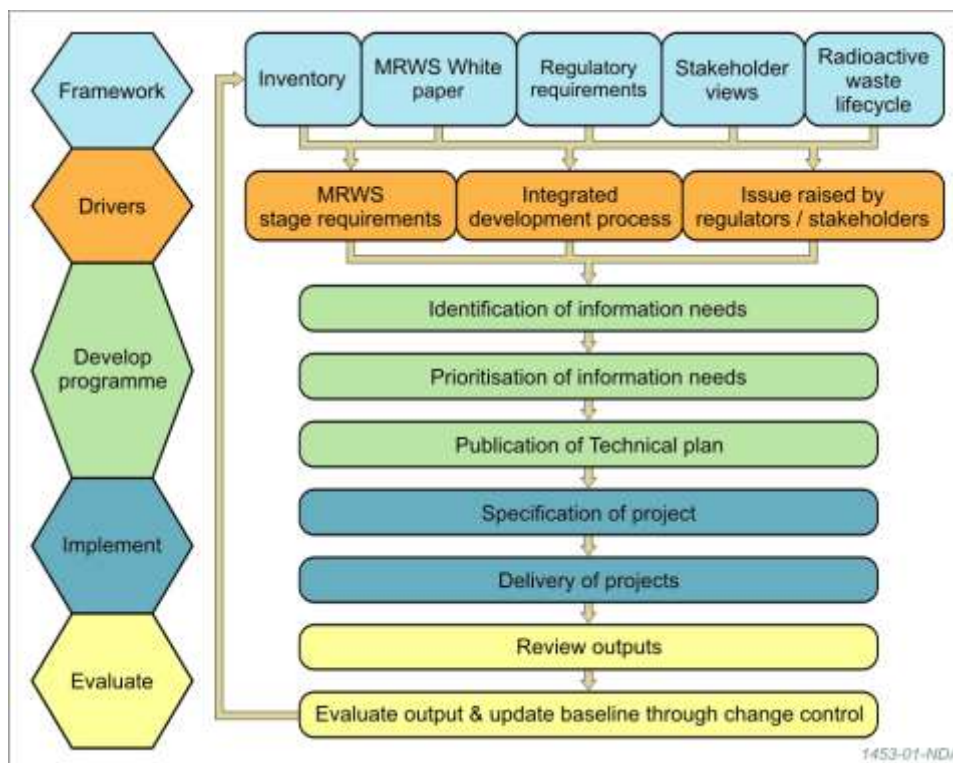

In development of the detailed technical programme of work, a structured list of seven questions is used, which includes an assessment of the importance or significance of a need (the impact), how much more is needed to be known (the knowledge gap), and at what stage of the programme the results are needed (the urgency). Each of these is assessed as high, medium or low.

The seven structured questions are as follows.

- What is the driver for work?
- What does RWMD need to know by when?
- How important or significant is this topic?
- What is the 'knowledge gap'?
- What is needed to do to fill it?
- How long will it take?
- How urgent is the task?

The exact timing of individual activities will also depend on a number of additional factors including:

- opportunities such as those for collaboration in joint international programmes;
- development and maintenance of key skills in the supply chain;
- reducing the risk carried by the project by bringing forward some pieces of work;
- resource levelling; and
- available budget.

5. Re-evaluation of the evidence

In order to ensure quality in delivery, a proactive approach is taken to contract management with a particular focus on technical quality. Regular progress meetings are held throughout the contract duration and these frequently involve independent experts who in turn contribute to the direction of the ongoing R&D.

In order to ensure quality in outputs, deliverables reporting on the outcomes of commissioned R&D tasks are required to be in the form of contractor-approved reports. This means that they will have been subjected to the supplier's own internal review and approval processes, as specified in their organisation's quality procedures, before they are submitted as final deliverables. In addition, work is reviewed by RWMD to check that the work meets the requirements specified in the invitation to tender and to ensure that the work is of an acceptable scientific quality. Where appropriate, external subject experts are commissioned to provide independent peer reviews of R&D outputs. Individuals are selected who have a high technical standing in their particular field, which is recognised at a national and/or international level. Attempts are made to ensure that the field of reviewers utilised is as broad as practicable and to include overseas experts as well as UK experts. Thus the review processes used for R&D commissioned by RWMD are in line with those generally accepted as good practice in the wider scientific community. Increasing priority is being placed on the publication of research results from the RWMD programme in the scientific peer-reviewed literature as this will again increase confidence in the quality of the science.

Further confidence in the RWMD Technical programme is provided by oversight arrangements. Oversight of the R&D Programme is provided by RWMD's Technical Advisory Panel. The panel meets three times a year and provides input on the scientific content and delivery of the programme. The panel may also access other independent subject matter experts as required.

Scrutiny of the R&D programme is also provided by the Committee on Radioactive Waste Management (CoRWM).

The Technical programme is also subject to voluntary regulation by the appropriate regulators. At key milestones, the programme is also subjected to independent programme-

wide reviews, by bodies with national or international standing, such as the Nuclear Energy Agency (NEA).

6. Evaluating new knowledge

Evaluation of R&D outputs is an important step in R&D process as this is the stage where the implications of R&D outputs for the geological disposal project are assessed. Evaluations of individual tasks are carried out on task completion.

The evaluations assess:

- the extent to which the research objective has been met;
- the implications of the R&D for the specification, design or assessment;
- the requirement for any follow-on R&D; and
- other benefits gained from the R&D.

The findings of the peer review form an important input to the evaluation process.

Evaluation of R&D outputs is an important component of the role of an RWMD research Manager as part of the 'intelligent customer' role. However, frequently, external experts from technical specialist organisations, academia and overseas waste management organisations are invited to contribute to the evaluation, in order to ensure that the evaluation is balanced. This new knowledge and its implications are then recorded in the status reports and become part of the scientific evidence base underpinning geological disposal. In addition, periodic evaluations are carried out of specific topic areas and of the whole R&D programme. These wider reviews ensure that the evidence from R&D by third parties, particularly the academic community and work in support of overseas geological disposal programmes is captured and evaluated in the context of the UK programme.

7. References

- [1] Department for Environment, Food and Rural Affairs, Department for Business, Enterprise and Regulatory Reform, Welsh Assembly Government, and Northern Ireland Department of the Environment, *Managing Radioactive Waste Safely: A Framework for Implementing Geological Disposal*. Cm 7386, ISBN 0101738625, June 2008.
- [2] Defra, DTI and the devolved administrations of Scotland, Wales and Northern Ireland, *Policy for the Long Term Management of Solid Low Level Radioactive Waste in the United Kingdom*, PB 12522, March 2007.
- [3] Defra, NDA and Pöyry Energy Limited, *The 2007 Radioactive Waste Inventory: Main Report*, Defra/RAS/08.002, NDA REPORT NDA/RWMD/004, 2008.
- [4] The Health and Safety Executive, the Environment Agency, the Scottish Environment Protection Agency and the Office for Civil Nuclear Security, *Guide to Regulatory Processes for Generic Design Assessment of New Nuclear Power Stations*, January 2007.
- [5] The Environment Agency, *Process and Information Document for Generic Assessment of Candidate Nuclear Power Plant Designs*, January 2007.
- [6] International Atomic Energy Authority Agency, *Scientific and Technical Basis for Geological Disposal of Radioactive Wastes*, Technical Report Series, 412, 2003.
- [7] NDA, *Geological Disposal: An overview of the generic Disposal System Safety Case*. NDA Report No. NDA/RWMD/010, 2010.
- [8] NDA, *Geological Disposal - Proposed Approach to Optioneering*, NDA Technical Note no. 12860687 2010.

MANAGEMENT OF RADIOACTIVE WASTE AND DISMANTLING OF NUCLEAR FACILITIES - THE FRENCH EXPERIENCE

GÉRALD OUZOUNIAN

ON BEHALF OF THE FRENCH NUCLEAR INDUSTRY

G.I.I.N., 39-41 rue Louis Blanc, 92400 Courbevoie, France

ABSTRACT

Like any human activity, the use of the properties of radioactivity in various economic sectors entails the production of waste. Radioactive waste consists of radioactive substances for which no subsequent use is planned or intended. In France, most radioactive waste, whether expressed in terms of volume or activity, is generated by the nuclear power industry. Among the waste streams, large volumes are produced when dismantling nuclear facilities that have reached the end of their life.

This article, giving a general presentation of the activities related to the management of radioactive waste in France and to the dismantling of nuclear facilities at the end of their life, introduces the French context of these activities and the corresponding industrial organisation.

1. The nuclear power cycle and the production of radioactive waste

The reference option for the French nuclear power cycle consists in recycling all recoverable materials under the economic conditions at the time. The cycle begins with the production of uranium ore, continues with chemical treatments, followed by enrichment in ^{235}U to make the fuel. After several years in a reactor, the fuel is unloaded, then processed in the AREVA facilities at La Hague. The uranium and the plutonium extracted by processing are recovered by recycling, and used in the production of new fuel, including MOX.

All the operations, from chemical treatment of the ore to processing of spent fuel and production of new fuel, produce radioactive waste. In France, this waste is classified according to the disposal solutions that are used to make it safe, i.e. protect humans and the environment from the radionuclides that it contains, now and for the future.

Three principal streams of radioactive waste are generated during the lifetime of nuclear facilities:

- The first stream consists of waste from operation and routine maintenance of the facilities; it comprises disposable items such as gloves and overshoes, cleaning materials, filters, ion exchange resins and used equipment. It is classified as short-lived low and intermediate level waste. It is disposed of in France at the Aube low and intermediate level waste disposal facility (CSFMA), at Soulaines.
- The second stream, generated during reactor operation, consists of conditioned waste from processing of spent fuel. This comprises vitrified high-level waste, containing fission products and minor actinides, and compacted ends and hulls or fuel structure residues, which are classified as long-lived intermediate-level waste. It is foreseen that from 2025, this waste stream will be disposed of in a geological formation in the Meuse Callovo-Oxfordian argillite.
- The third stream is generated mainly at the end of life of nuclear facilities during dismantling. It consists of equipment withdrawn from service and decontaminated, structural rubble and scrap metal and all the dismantling materials. This is very-low-level waste, disposed of at the very-low-level waste disposal facility (CSTFA), at Morvilliers.

A fourth radioactive waste stream should be mentioned. It consists of the waste produced by dismantling of the first gas-cooled graphite reactors, together with ore processing

residues from the production of rare-earth elements. This is low-level waste, but includes significant quantities of long-lived radionuclides, mainly ^{14}C , ^{36}Cl and radium. These radioactive waste streams are shown in the French classification, published by decree [1]; it is based on criteria of half-life and level of the radioactivity contained in the waste, and on the physical and chemical characteristics and the source of the waste.

2. The institutional framework of radioactive waste management in France

Very early, France opted for safe disposal of waste and protection of humans and their environment by surface disposal. A first Radioactive waste disposal facility was commissioned in 1969. Most of the waste disposed of at this facility was generated by reactor operation and by research activities. It is short-lived low-and-intermediate-level waste. The facility was operated for 25 years, and the volume disposed of was 527,000 m³. In 1992, the CSFMA was commissioned, with a capacity of 1 million m³, today considered sufficient to accommodate all the short-lived low-and-intermediate-level waste generated by operation of power reactors in France.

The CSTFA was commissioned in 2003, with a capacity of 650,000 m³. To accommodate the volume of waste produced by the dismantling of nuclear facilities over the coming years, new disposal capacities will have to be considered after 2025. In parallel, major efforts to reduce waste volumes, for example by recycling, are being undertaken. The statutory framework for radioactive waste management has been developed gradually with experience since 1969. In particular the nuclear safety requirements, the requirements for the characteristics of the disposal sites, the waste stabilisation and conditioning specification requirements and the conditions of acceptance of radioactive waste in disposal facilities have been defined. Many documents have been published by ASN, the nuclear safety authority, providing guidance for all radioactive waste management operations. Basic safety rules (RFS), including RFS-3.2.e on prior conditions for approval of solid waste packages for surface disposal [2], and guides are regularly published and updated.

The institutional framework for radioactive waste management has been put into place more recently, supported by a strong political commitment and huge R&D efforts. The first act was passed in 1991, covering research on the management of high-level waste and long-lived intermediate-level waste. An assessment of the results was drawn up after the stipulated 15 years of research. The technical feasibility of the geological disposal option was demonstrated in 2005. The demonstration was accompanied by all the information needed to consider that long-term safety could be demonstrated in the Callovo-Oxfordian argillite. Following a public debate conducted at the request of the government, a new act was debated and passed in 2006 [3]. In accordance with the demands expressed during the public debate, the scope of the act was extended to all radioactive waste.

The 2006 act stipulates that a management plan for radioactive materials and waste be published every three years. The plan assesses the existing radioactive materials and waste management modes, surveys forecast needs for storage or disposal facilities, defines the necessary capacities of these facilities and the storage times, and defines the objectives for radioactive waste that is not yet covered by a final management mode. The national plan also organises the implementation of research and studies on radioactive materials and waste management, defining deadlines for the implementation of new management modes, the construction of facilities or the upgrading of existing facilities to meet the needs and the objectives. The plan must comply with the following guidelines:

- reduction of the quantity and toxicity of radioactive waste, including by processing of spent fuel and treatment and conditioning of radioactive waste;
- storage of radioactive materials pending treatment and final radioactive waste pending disposal;

- after storage, geological disposal of final radioactive waste which, for nuclear safety or radiation protection reasons, cannot be disposed of in surface or near-surface facilities.

The National Plan is drawn up under the responsibility of the government and submitted to Parliament; it is made public.

The preparation of the plan is based on the inventory of radioactive materials and waste, also updated every three years, published by Andra. The latest edition was published in June 2012 and is available on the Internet [4].

The publication of a national inventory and a national radioactive materials and waste management plan is now required in Europe within the framework of the 2011 European Directive on management of spent fuel and radioactive waste [5].

Last, the 2006 act consolidates the regulatory framework relating to the financing of radioactive waste management and dismantling.

3. The dismantling framework

Like all industrial facilities, nuclear facilities at the end of their operating lifetime are dismantled, prior to release of the site on which they are located or reuse of the site for another activity. The act of 13 June 2006 on nuclear transparency and safety [6] defines the framework for taking account of the dismantling of nuclear facilities.

A basic nuclear installation construction licence can only be delivered if the principles of the future dismantling of the installation have been examined beforehand. The disposal of the waste that will be produced during dismantling must also have been taken into consideration. The costs of the future operations must have been estimated so that installation dismantling, site rehabilitation, monitoring and upkeep, and waste disposal can be carried out when the time comes.

Provisions relating to decommissioning conditions, dismantling procedures and waste management, as well as subsequent monitoring and upkeep of the site, must be proposed. The goal is to prevent or sufficiently limit the risks or drawbacks with regard to security and public health, and to protect nature and the environment.

The decommissioning of a nuclear facility and the undertaking of dismantling work are subject to licences. In all cases, they must be planned in compliance with the regulations in force, including with regard to protection of the health of workers and the public and protection of the environment. The licence application is drawn up under the responsibility of the facility operator, and then examined by the ASN.

The safety of facilities undergoing dismantling is based in the first instance on the control applied by the facility operator. In this context, ASN verifies, for each facility, that the organisation and the means implemented by the operator enable it to assume this responsibility. In addition to the individual dismantling of each facility, ASN makes sure that the overall strategies of the operators form part of a consistent approach to taking into account the safety and radiation protection constraints. The magnitude of the current dismantling programmes demands thorough planning, taking into account all the parameters related to safety and radiation protection: facility ageing, initiation decision-making, technical options and safety priorities.

4. Radioactive waste management in France

The National Inventory of Radioactive Materials and Waste published in 2012 reports on the various categories of waste on French territory. A summary is given in table I.

Waste volume (m ³)	Waste at end-2010	Forecast end-2020	Forecast end-2030
HLW	2,700	4,000	5,400
ILW-LL	41,000	45,000	49,000
LLW-LL	87,000	89,000	133,000
LILW-SL	830,000	1,000,000	1,200,000
VLLW	360,000	750,000	1,300,000
Total	~1,320,000	~1,900,000	~2,700,000

Tab I: Summary of the radioactive waste inventory in France and forecasts

Table I shows that most of the volume of radioactive waste consists of operating waste (LILW-SL) and dismantling waste (VLLW). The volume of waste generated by spent fuel processing (HLW and ILW-LL) is relatively small. The same applies to the production forecasts up to 2020 and 2030. Disposal capacities must be available for all the waste that will have been produced by the present nuclear power plants. The breakdown of the radioactive waste by activity shows that the cumulative activity of waste other than HLW and ILW-LL amounts to only about 0.01% of the total radioactivity, for more than 96% of the total volume.

At present, there are three disposal facilities in France:

- the Manche disposal facility, in the monitoring phase since 2003 for 300 years; the monitoring covers the structures, the water drainage systems and the environment;
- the CSFMA facility, accepting 12,000 to 15,000 m³ of short-lived low-and-intermediate-level waste each year, along with large components which are also disposed of there, in particular pressurised water reactor vessel heads that are replaced by EDF;
- the CSTFA facility, receiving increasing quantities of very-low-level radioactive waste as dismantling of facilities progresses.

Aerial views of each of the two operating disposal facilities are shown in figure 1.



Fig 1. Aerial views of the CSFMA (left) and the CSTFA (right)

High-level waste and long-lived intermediate-level waste will be disposed of in a geological formation, the reference option given in the 2006 act. The research conducted on the site since 1994, and then since 1999 at the Meuse/Haute-Marne underground laboratory, in Bure, have paved the way for the industrial phase of the Cigéo geological disposal facility project. The underground location of Cigéo has been confirmed by the government, and its surface facilities are under discussion with local representatives.

The overall architecture of the geological disposal facility is shown in figure 2. Disposal will be in a predominantly clayey formation, the Callovo-Oxfordian argillite, at a depth of about

500 m. Personnel access to the disposal area will be by shafts. The waste packages will be transferred along a ramp about 5 km long, with a slope of about 1 in 10.

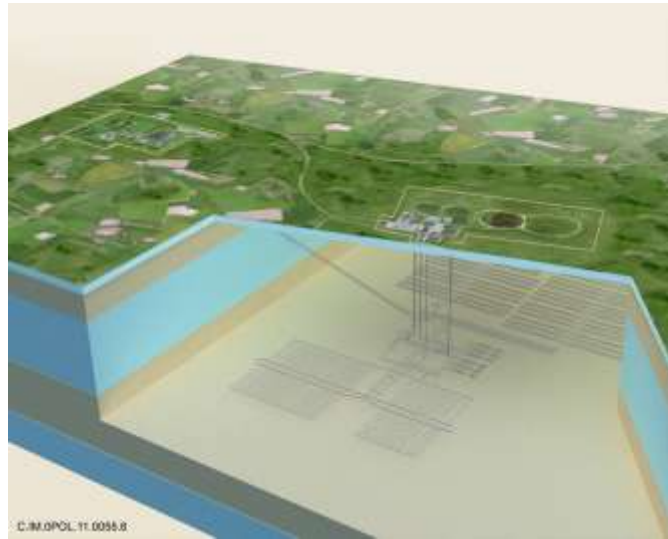

Fig 2. Overall architecture of the Cigéo geological disposal facility project

The project is still in the design stage. It must be presented during a public debate planned in 2013. The final location will then be chosen, and the construction and operating licence application will be submitted in 2015. A parliamentary debate is planned in 2016 on the reversibility conditions. Construction work should begin in 2019, after the licence has been obtained, with a commissioning target date of 2025.

5. Situation of dismantling programmes in France

The civil nuclear industry expanded in France in the 1960s. Several facilities built during this period are reaching the end of their life and their operation for production or research is stopping. They must then be dismantled, which involves cleanup and demolition.

As of 2010, more than thirty nuclear facilities, including the eight reactors of the first-generation EDF nuclear power plants, were undergoing decommissioning and dismantling.

The dismantling of nuclear facilities usually involves long-term operations, challenging for the facility operators in terms of project management, skill retention and coordination of the various works. The radioactive materials must be removed and the facility dismantled and cleaned up. These operations raise particular issues in terms of:

- dosimetry, as the workers often have to be in contact with equipment containing radioactive substances in order to dismantle it;
- management of unusable radioactive materials from the nuclear industry, medical centres or laboratories;
- conventional risks, insofar as some operations are equivalent to demolition work as carried out in the construction sector;
- risks related to loss of design and operation knowledge and retention of skills;
- risks related to inadequate monitoring potentially leading to eventual pollution of the site or its environment.

The facilities for which dismantling is under way are shown on the map in figure 3.

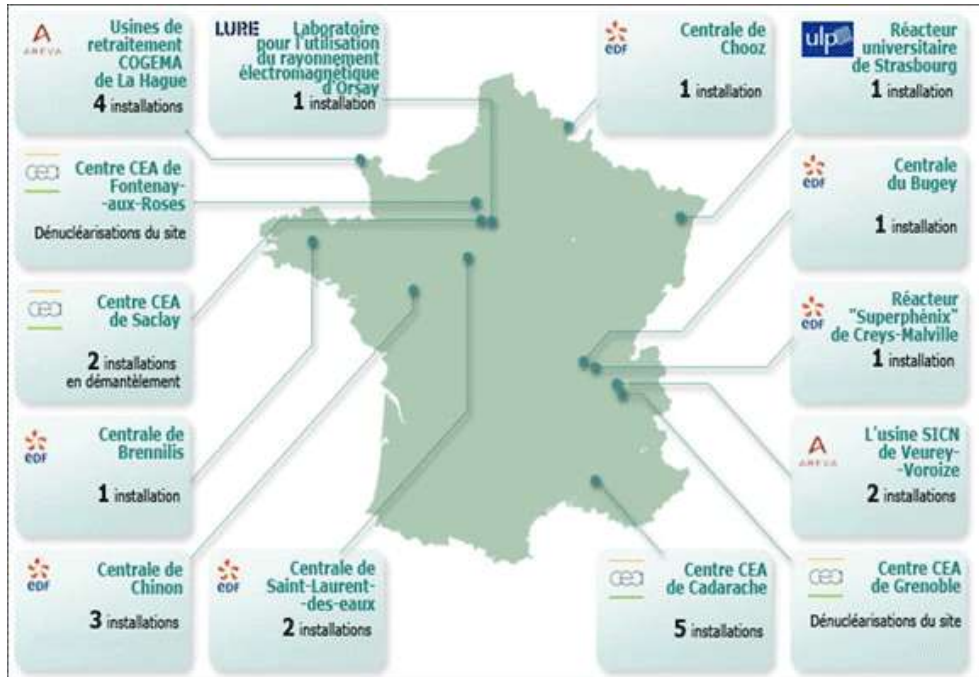

Fig 3. Facilities being dismantled (source ASN- Nuclear Safety Authority)

The facilities being dismantled are listed in table II.

<p>EDF first-generation reactors:</p> <ul style="list-style-type: none"> • Chinon plant • Bugey plant • Saint-Laurent-des-Eaux plant 	<p>CEA facilities</p> <ul style="list-style-type: none"> • Cadarache site <ul style="list-style-type: none"> ○ Plutonium technology workshop (ATPu) ○ Enriched uranium workshop (ATUE) ○ Chemical purification laboratory (LPC) • Grenoble site <ul style="list-style-type: none"> ○ Mélusine facility ○ Siloé facility ○ Very high activity laboratory (LAMA) ○ Effluent and solid waste treatment station ○ Storage and decay facility • Fontenay-aux-Roses site <ul style="list-style-type: none"> ○ Procède facility ○ Support facility
<p>Other EDF reactors:</p> <ul style="list-style-type: none"> • Superphénix fast breeder • Chooz B plant (pressurised water reactor (PWR)) • Brennilis plant (heavy water reactor 4 (EL4)) 	
<p>Other facilities being dismantled:</p> <ul style="list-style-type: none"> • AREVA NC reprocessing plants at La Hague • SICN site at Veurey-Voroize 	

Tab 2: Facilities being dismantled

The number of French nuclear facilities, and consequently of facilities reaching the end of their life, has necessitated the development of a sector specialised in dismantling. The companies traditionally involved in the nuclear sector have been able to make use of their skills by providing their services for dismantling of facilities. These include nuclear engineering specialists such as AREVA, ONET Technologies, SUEZ and ASSYSTEM. They work for the major contracting entities, such as EDF, and the CEA; they also support specialised in-house engineering teams that have been set up, for example at EDF. Construction industry demolition firms have also acquired the specific skills related to radiological risks and have developed their experience in the dismantling sector (VINCI, EIFFAGE, NUVIA, FREYSSINET, SPIE, BOUYGUES, etc.). They are now working on the various dismantling projects and sites, both in France and in other countries.

Many specialist companies in decontamination, remote manipulation, storage and transport or radioactivity monitoring are also involved in dismantling, including ROBATEL, DAHER and many others.

6. Conclusion

France, through its experience with nuclear power and thanks to the large number of plants it has built, has an industry specialised in nuclear engineering. It has all the skills, and has now accumulated more than 40 years of experience, which are now being put to use in radioactive waste management and the dismantling of nuclear facilities.

Effective links between dismantling and radioactive waste management specialists enable better optimisation of waste production and matching of waste sorting to the disposal solutions. For this, ANDRA, the national radioactive waste management agency, works as far upstream as possible in the dismantling operations, in collaboration with the engineering teams and the contractors involved in the dismantling of nuclear facilities.

References

- [1] Decree no. 2012-542 of 23 April 2012 on application of article L. 542-1-2 of the environmental code and setting down the requirements of the national management plan for radioactive materials and waste
- [2] RFS-3.2.e *Conditions préalables à l'agrément des colis de déchets solides enrobés destinés à être stockés en surface* (prior conditions for approval of bituminised solid waste packages for surface disposal) (revised 29 May 1995)
- [3] Consolidated version of *Planning Act No. 2006-739 Concerning the Sustainable Management of Radioactive Materials and Waste*, <http://www.andra.fr/publication/produit/loi-VA-12122006.pdf>
- [4] <http://www.andra.fr/inventaire2012/#/accueil/>
- [5] Council directive 2011/70/Euratom of 19 July 2011 establishing a Community framework for the responsible and safe management of spent fuel and radioactive waste
- [6] Act no. 2006-686 of 13 June 2006 on nuclear transparency and safety

ENC
2012

EUROPEAN NUCLEAR CONFERENCE



**POSTER:
END OF USE**

DESTRUCTION OF LIQUID ORGANICS IN RADIOACTIVE WASTES USING ADSORPTION AND ELECTROCHEMICAL REGENERATION

N.W. BROWN, A. ADAMS
*Arvia Technology Ltd,
Daresbury Innovation Centre, WA4 4FS UK*

D. WICKENDEN
*Magnox Ltd
Berkeley Centre, GL13 9PB, UK*

E.P.L. ROBERTS
*School of Chemical Engineering, University of Manchester,
Manchester, M60 1QD, UK*

ABSTRACT

An innovative approach to the destruction of radioactive oils and liquids using adsorption and electrochemical regeneration is reported based on a highly conducting carbon-based adsorbent material, Nyex™, that can be regenerated via low-voltage, direct electric current. On-site demonstration trials at Trawsfynydd nuclear decommissioning site have shown that the process is robust in treating a range of ILW and LLW oils with regeneration energy requirement of 42.5 kWh/l. The majority of the radioactivity (80 – 90%) partitioned into the water phase and all secondary wastes could be handled by existing site disposal routes. Further laboratory treatability trials showed that other organic liquids could be treated including morpholine, EDTA and PCBs, with similar regeneration energy requirements.

1. Introduction

A significant problem at nuclear reactor sites is the treatment of radioactive contaminated oil and organic wastes. Treatment of these wastes prior to disposal, particularly those with high activity levels, has proven to be difficult as existing methods of incineration and cementation/encapsulation have proven either very costly or ineffective. To address the problems with these techniques, destruction of the organics by other oxidative methods has been investigated. These include chemical (1), photocatalytic (2), electrochemical (3), supercritical water (4), biological (5) and plasma. None of these have yet proven technically or economically viable.

An example of difficult organic wastes are LLW and ILW oils contaminated with alpha radioactivity at a Magnox Ltd nuclear decommissioning site at Trawsfynydd in the UK (6). The current Magnox baseline disposal route for waste oil is incineration, however, this route is not available for significantly contaminated oil and hence these wastes have been identified as orphan wastes or wastes requiring additional treatment (WRAT).

1.1 The Arvia Process

Arvia have developed an innovative approach for the removal and destruction of aqueous organics in the treatment of water and wastewater using adsorption coupled with electrochemical regeneration. This is based on a highly conducting carbon-based adsorbent material, Nyex™, that can be regenerated via low-voltage direct electric current. Treatment can either be via continuous or batch operation.

Arvia and Magnox have been working together over the past three years to demonstrate that the Arvia™ Process for water treatment (7-9) can be applied to the destruction of radioactive oils. The Arvia™ Process for oil destruction comprises four stages:

Emulsification – the oil is emulsified in water (using an organic emulsifying agent and a high shear mixer) to give a stable emulsion.

Adsorption - is achieved by mixing the Nyex™ and effluent through fluidising the adsorbent particles, where vigorous mixing and the non-porous nature of the Nyex™ results in quick adsorption.

Sedimentation - results when the fluidising air is switched off and the dense Nyex™ particles settle rapidly under the influence of gravity to form a bed.

Electrochemical Destruction - two electrodes are placed either side of the bed of particles and a direct electric current is passed through the bed which destroys the pollutant through anodic oxidation of the organic matter to water, carbon dioxide and small amounts of hydrogen, carbon monoxide and chlorine. This serves to regenerate the adsorbent. The regenerated adsorbent is then ready for immediate reuse and the whole cycle is repeated.

This paper reports the results of a large scale demonstration trial treating high alpha LLW and ILW oils at Trawsfynydd.

However there are other radioactive organic liquids present on nuclear sites which are also difficult to treat, for example chelating agents (Ethylenediaminetetraacetic acid - EDTA), corrosion inhibitors (morpholine) and PCBs. This paper compares laboratory scale results from the treatment of these compounds with results obtained from the treatment of radioactive oils.

2. Experimental Method

2.1 Large-Scale Demonstrator Plant at Trawsfynydd

Laboratory scale work was undertaken in Arvia's mini-sequential batch reactor (Figure 1A) to prove inactive oil destruction and the potential for gaseous emissions. On-site treatment was achieved using Arvia's "Titan" demonstration unit (Figure 1B).

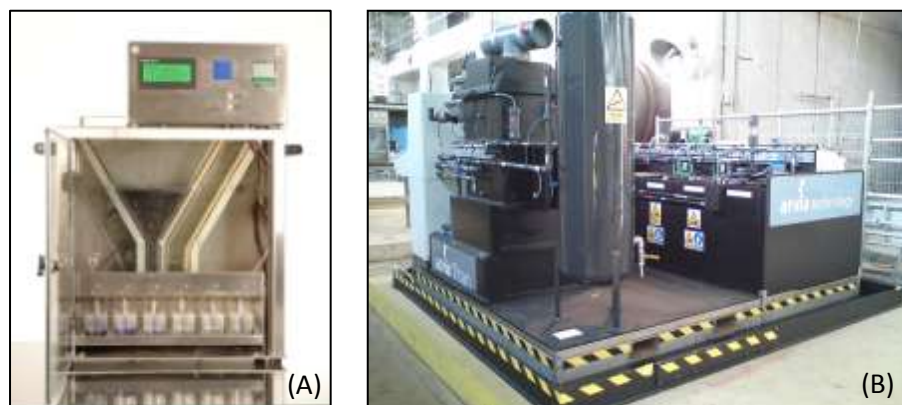

Fig 1. Arvia Test Units (A) Mini-SBR; (B) Titan

Oil was destroyed at Trawsfynydd by adding small quantities of oil-water emulsion to the reactor tank over a period of time. Fivelitres of high alpha LLW (LLWO/11/09) and five litres of ILW (JN54) oils were added. This report covers the data from the ILW oil as the LLW oil provided a very inhomogeneous waste, resulting in significant variation.

Samples were taken of the supernatant effluent, the catholyte and the Nyex™ and sent to GAU Radioanalytical Laboratories for radiochemical analysis. The organic content in the liquid phase was measured on-site by COD (Chemical Oxygen Demand) using Hach COD vials (0-1,500 mg/l vials using appropriate dilutions) and a DR90 Colorimeter.

2.2 Treatability

Treatability trials were undertaken in one of Arvia's laboratory scale batch reactor (Figure 2) where a number of individual pollutants were tested (Table 1). Trials involved adding 100 g of Nyex to the reactor where a 1,000 ml solution containing a known concentration of the pollutant was added. Treatment was achieved over a number adsorption/regeneration cycles. A range of different techniques were used to assess pollutant removal. Sodium chloride was used to make up a 0.3% catholyte brine solution and hydrochloric acid and sodium hydroxide were used for pH adjustment. These were supplied as analytical grade by Fisher. The adsorbent used in the trials was Arvia's Nyex 1000.



Fig 2. – Laboratory scale batch reactors (1-cellsystem (L) 4-cell System)

Contaminant	Regeneration Time (mins)	Current (A)	Initial concentration	Treatment method	Analytical method
Turbine Oil (Tellus 46)	240	5	1%	1	Fluorescence
EDTA	30	0.5	0.1%	2	COD
Morpholine	30	0.5	0.2%	2	COD
PCB	10	0.5	1 mg/l	3	External Lab

Treatments

- 1000 ml of oil emulsion solution was added to the test unit for a number of adsorption/regeneration cycles keeping the same solution within the unit after each cycle. After a number of cycles a further quantity of concentrated oil emulsion was added to give a supernatant oil concentration of 1%. This was repeated after a further number of cycles. Treatment was in Arvia's 4 cell oil test unit.
- 1000 ml of solution was added to the test unit for a number of adsorption/regeneration cycles keeping the same solution within the unit after each cycle.
- 1000 ml of solution was added to the test unit and the supernatant was removed after each adsorption/regeneration cycle and replaced with a further 1000 ml of the same solution.

Tab 1: Experimental details

The quantity of the oil in the supernatant and on the Nyex was assessed by fluorescence testing (Horiba Jobin Yvon Fluoromax-3 fluorimeter (10)). Aqueous organics concentration was measured in the supernatant by COD analysis (using Hach COD 0-1,500 mg/l tubes (with sample diluted to correct range) and a Camlab DR 890 colorimeter) or, for individual species, by an external laboratory, SAL (Manchester, UK).

3. Results and Discussion

For clarity this section has been split into two parts. The first part describes the results from Trawsfynydd and the second reports the laboratory treatability data, comparing the results with the destruction of oil.

3.1 Trawsfynydd Trials Results

Adsorption of the oils results in the partitioning of the oil between the aqueous phase and the Nyex™. To demonstrate the removal of oil from the aqueous phase, the Chemical Oxygen Demand (COD) of the liquid phase was monitored on a regular basis.

Initially inactive Tellus 46 oil was used to commission the “Titan” unit. The COD of the oil / water solution in the treatment tank (assuming no oil was removed) was calculated to be 90,400 mg/l. Off-site and on-site commissioning trials operated for 46 and 43 hours respectively, with resultant CODs of the supernatant solution after treatment being 750 and 280 mg/l respectively. This gives oil removal rates in excess of 99%.

On-site destruction of the active oils was also followed by COD analysis. The predicted COD at the end of the trial assuming no oil was removed from the supernatant emulsion was calculated as 70,000 mg/l. The supernatant COD values (after dilution at 50:1) at the end of the trial were 0 mg/l (Limit of Detection = 6 mg/l) showing that the oil had been successfully removed from the oil/water emulsion.

To process 4.5 l of oil, the Titan was operated at a fixed current of 25 A, where the average voltage across the 6-cell stack was 16 V (Figure 3), giving an energy consumption of oil treated as 42.5 kWh/l. The reduction of voltage over time is due to the increase in liquid conductivity and reduction in liquid pH due to the addition of hydrochloric acid.

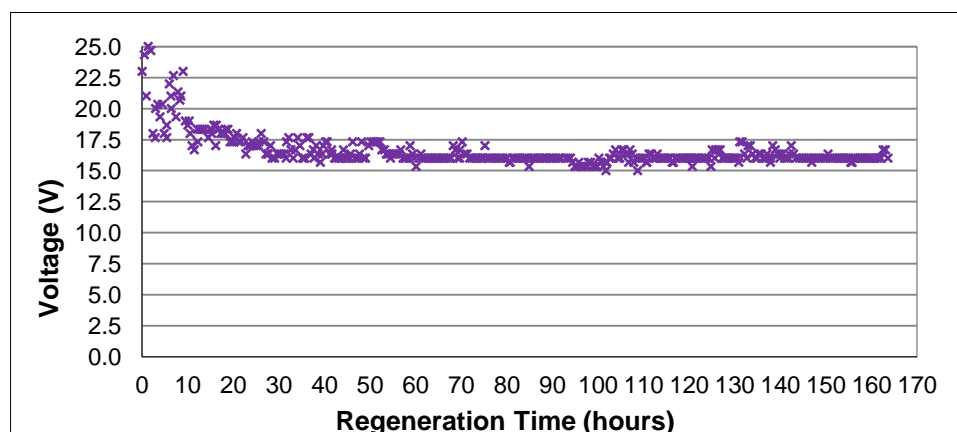

Fig 3. Average voltages per cell stack of 6 cells during the regeneration at a current of 25 A

The Mini-SBR (Figure 1A) was to provide an assessment of the secondary radioactive wastes, particularly with reference to the gaseous phase. Since the process produces hydrogen and other gases, the possibility that radioactive species, particularly tritium, could end up in the gaseous phase was considered. The undiluted gaseous outlet from the mini-SBR was passed through a furnace at 600 °C containing a copper catalyst, to oxidise any tritiated species to tritiated water, and then through two *Dreschner* bottle traps. Scintillation counting was used to quantify of activity in the liquid phase, which allowed the gaseous phase activity to be calculated. These results showed that only negligible amounts of tritium were detected, requiring no further treatment before direct discharge to atmosphere.

The performance of the Arvia Process in treating inactive oil and two different active oils using the same treatment unit with the same operating conditions (current density 10 mA/cm² regenerating for 20 hours per litre oil destroyed) demonstrates that the process is robust enough to cope with variations in the incoming feed. Table 2 below shows how key parameters compare between the different oils during on-and off-site trials.

Type of oil	Operational parameters (V/stack)	Regeneration Power (kW)	Energy (kWh/l)
Tellus 46 (neat inactive) Off-site	20.7	1.55	47.9
Tellus 46 (neat inactive) On-site	22.3	1.73	47.5
LLW Oil 11/09	16	1.2	42.5
ILW Oil (JN54)	16	1.2	42.5

Tab 2. Comparison of key parameters treating different oils

3.2 Summary of Radioactivity Partitioning

Baseline analysis of the ILW oil employed in the trial was undertaken by GAU Radioanalytical Laboratories (11) is reported in Table 3.

Nuclide	Co-60 ¹	Cs-137 ¹	Eu-154 ¹	Eu-155 ¹	Am-241 ^{1,3}	H-3 ²	C-14 ²	Fe-55 ²	Cl-36 ²	Ni-63 ²	Sr-90 ²	Pu-239 /- 240 ³	Pu-238 ³
Specific Activity (Bq/g)	2.1±0.1	2.9±0.2	87±5	24±3	1130±70 1030±50	8±1	1.1±0.2	3.3±0.6	<0.2	17±2	1200±120	99±9	300±20

¹Gamma spectrometry / ²Beta Spectrometry / ³Alpha spectrometry

Tab 3: Baseline activities for the active oils

Throughout the oil processing trials, samples of the secondary waste phases were taken for analysis by GAU. Table 4 summarises the partitioning of activity between the liquid phase and the NyexTM. This shows that 80 - 90% of the activity is associated with the liquid phase and 10 – 20% associated with the solid NyexTM phase. Data related to Cl-36, Fe-55 and Ni-63 are not reported since their observed waste activity concentrations were, typically at or below the analytical limits of detection.

Nuclide	% Observed Activity Distribution	
	Liquid Phase	Nyex TM Solid Phase
H-3	70	30
Co-60	91	9
Eu-154	88	12
Eu-155	89	11
Sr-90	85	15
Cs137	61	39
Am-241 (γ-Spec)	88	12
Am-241 (α-Spec)	88	12
Pu- 239/240	87	13
Pu-238	87	13

Tab 4: Radioactivity partitioning data (average values for 3 ILW trials)

To confirm that the no problem wastes were generated, at the end of the trial the plant was dismantled for disposal. All wastes could be disposed of through existing Magnox site disposal routes, specifically the supernate (combined catholyte and electrolyte) and NyexTM were removed and processed as follows:

- The recovered supernate and associated cell washings were neutralised using 47 % w/v sodium hydroxide to a pH of between 6 and 8 and successfully discharged to the site active effluent treatment plant (AETP) for disposal via the site active drain.

- The spent Nyex™ graphite flake adsorbent was collected in a 205 litre drum as a wet cake. When dry, this will equate to less than 50 litres of LLW Nyex™ to be transported to the UK Low Level Waste Repository for final disposal.

3.3 Laboratory treatability

Whilst following the COD in the liquid phase demonstrates that the oil is being removed from the water, there could be a build-up on the Nyex™. Hence a fluorescence method was developed (10) to demonstrate that the oil on the Nyex™ surface was being destroyed. Figure 4 shows that the Tellus oil on the Nyex™ surface is reduced over a number of regeneration cycles.

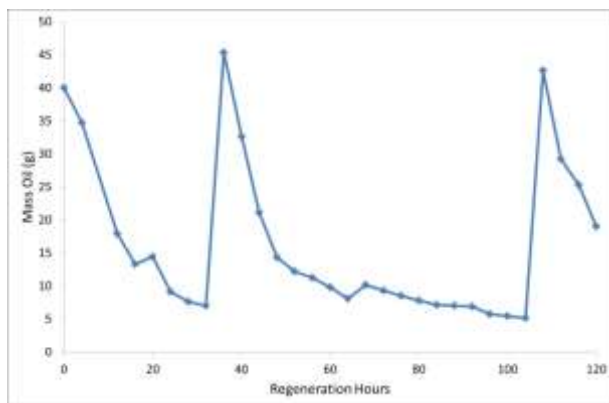

Fig 4. Tellus remaining on the adsorbent after a number of treatment cycles

EDTA and morpholine were also treated and the removal of these (as measured by supernatant COD) is shown in Figure 5.

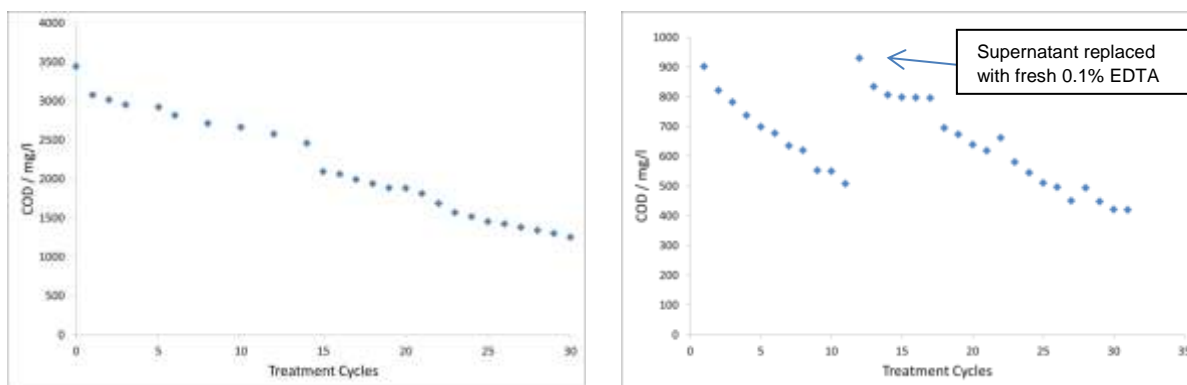

Fig 5. Removal of morpholine (left) and EDTA (right) over a number of treatment cycles by measuring the COD remaining in the supernatant liquid

The energy required to treat a litre of Morpholine and EDTA was calculated as 29.5 and 28.7 kWh/l.

The PCB trial was analysed using a fresh batch of PCB spiked water for each adsorption/regeneration cycle. Hence Figure 6 shows the % removal of the total PCBs after each cycle, demonstrating that if there is no regeneration then the removal efficiency decreases.

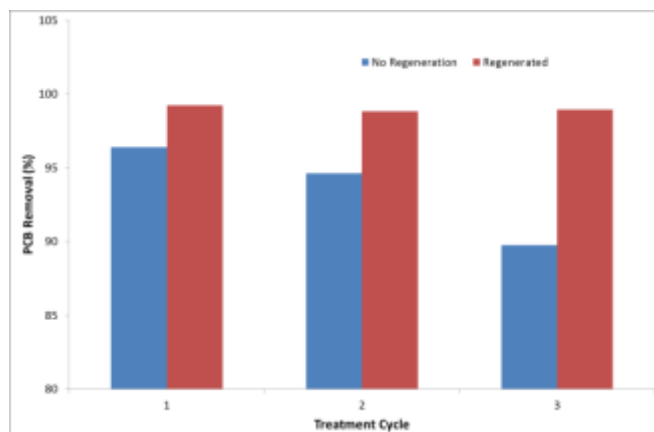

Fig 6. PCB concentration in the supernatant over a number of treatment cycles with and without regeneration when adding fresh total PCB solution each cycle

4. Conclusions

The Arvia™ process of adsorption coupled with electrochemical regeneration has successfully demonstrated the removal and destruction of LLW and ILW radioactive oils on a nuclear site. Over 99.9% of the emulsified oil was removed, with the majority of the radioactive species transferred to the aqueous, supernate phase (typically 80 – 90 %).

All secondary wastes were suitable for disposal using existing disposal routes, with the majority of the activity being successfully discharged as active water via the site active drains. Tritium gaseous discharges were negligible; hence no off-gas treatment before direct discharge to atmosphere is necessary.

A range of organic liquids have been treated by either dissolving or emulsifying in water to create an aqueous waste. Regeneration energy has typically been 22 – 50 kWh/l using standard operating conditions. This suggests that the process is robust enough to cope with a wide range of aqueous organics.

References

1. Fox, J.C., Fjeld, R.A., (1991) "Decontamination of Waste Lubricating Oil by Chemical Oxidation", Proceedings of the 36th Annual Meeting of the Health Physics Society, Washington, D.C., USA, 1991
2. Adams, M., Campbell, I., Robertson, P.k.J., (2008), "Novel Photocatalytic Reactor Developments for Removal of Hydrocarbons from Water" International Journal of Photoenergy, Article 67453, 2008.
3. Taylor, G.T., Sullivan, I., Newey, A., (2006) "Assessment of Electrodes from Wafers of Boron-Doped Diamond for the Electrochemical Oxidation of Waste Lubricants Proceedings of WM2006, Tucson, AZ 2006
4. Lin, K.S., Wang, Z.P., Chang, C.S., (2008) "Supercritical water oxidation of radioactive organic liquid wastes with salts recycling" Abstracts of Papers of The American Chemical Society, Volume: 236 Meeting Abstract: 71-NUCL
5. Jacobs, A., Everett, W., "A truly industrial solution for the elimination of radioactive oils or solvents" Proceedings of WM2010, Phoenix, Arizona
6. Wickenden, D. (2011) Innovative treatment of radioactive oil waste – The Arvia® Process. Proceedings of the 11th Tritium User Group Conference. 22nd – 23rd June 2011, Chapelcross UK.
7. Brown, N.W., Sanderson, D, & Campen, A.K. (2009) Magnox North Generic Research & Development Programme to Support Decommissioning and Waste Management" Arvia Technology Report No. 0908-3, Arvia Technology Ltd, Daresbury Innovation centre, Warrington, UK May 2009.

8. Brown, N.W., Campen, A.K. (2010) Decontamination Techniques, Electrochemical Degradation of Oil and Oil Water Arvia Technology Report No 0910-01. Arvia Technology Ltd, Daresbury Innovation centre, Warrington, UK March 2010
9. Brown, N.W., Campen, A.K., Eaton, D., Robinson, P. (2011) Onsite Active Oil Trial at Magnox Ltd (Trawsfynydd site) of the Arvia[®] Process Arvia Technology Report No 2010AT11-Final. Arvia Technology Ltd, Daresbury Innovation centre, Warrington, UK October, 2011
10. Dawes, M., Campen, A.K., Brown, N.W., Roberts, E.P.L., (2012) "Investigating the effectiveness of fluorescence spectroscopy in determining the mass of oil on an adsorbent used for treating radioactive oils" In Preparation
11. Warwick P. E. Radiochemical analysis of Nyex, effluent, catholyte, bubbler and electrode plates. (Sample ID: MO4 and TI01 – 06 samples) GAU Radioanalytical Laboratory Analytical report no 2337 – 2431 National Oceanography Centre, Southampton, UK October 2011

Acknowledgements

The authors would like to acknowledge the contribution made by Linda Hilton, Andrew Campen, David Sanderson, Don Eaton and Peter Robinson (Arvia Technology Ltd), Will Walker Jones and Clive Wright (Magnox Trawsfynydd Site), Ashok Patel and Brian Pepereke (Magnox Engineering Function), and Phil Warwick (GAU Laboratories, Southampton) for the analysis of the process secondary wastes.

MONITORING AND INSPECTION TECHNIQUES FOR LONG TERM STORAGE OF HIGHER ACTIVITY WASTER PACKAGES

G.T. BOLTON

*National Nuclear Laboratory
Chadwick House, Warrington, WA3 6AE, UK*

ABSTRACT

In 2009, following recent changes in Government Policy, the Nuclear Decommissioning Authority (NDA) identified a knowledge gap in the area of long term interim storage of waste packages. A cross-industry Integrated Project Team (IPT) for Interim Storage was created with responsibility for delivering Industry Guidance on the storage of packaged Higher Activity Waste (HAW) for the current UK civil decommissioning and clean-up programmes. This included a remit to direct research and development projects via the NDA's Direct Research Portfolio (DRP) to fill the knowledge gap. The IPT for Interim Storage published Industry Guidance in 2012 which established a method to define generic package performance criteria and made recommendations on monitoring and inspection. The package performance method consists of the following steps; identification of the package safety function, identification of evolutionary processes that may affect safety function performance, determination of measurable indicators of these evolutionary processes and calibration of the indicators into package performance zones.

This paper provides an overview of three projects funded by the NDA's DRP that the National Nuclear Laboratory (NNL) have completed to address monitoring and inspection needs of waste packages in interim storage.

1. Introduction

The UK Government White paper 'Managing Radioactive Waste Safely' published in June 2008 [1] confirmed that the Nuclear Decommissioning Authority (NDA) would continue to provide interim storage of waste across its sites until a Geological Disposal Facility (GDF) was available. The Committee on Radioactive Waste Management (CoRWM) published a report on interim storage in March 2009 [2] which called for a more strategic UK approach. In 2009, a cross-industry Integrated Project Team (IPT) for Interim Storage led by the NDA and made up of Site License Companies (SLCs) and other waste owners was created to address key issues such as waste package performance, store longevity, monitoring and inspection regimes and store maintenance & refurbishment. The IPT for Interim Storage indentified gaps in knowledge which were filled by performing research and development projects through the NDA's Direct Research Portfolio (DRP) over the period 2009-2012. The IPT produced Industry Guidance on the interim storage of HAW packages in 2012 [3] which established a method to define generic package performance criteria. The method consists of the following steps; identification of the package safety function, identification of evolutionary processes that may affect safety function performance, determination of measurable indicators of these evolutionary processes and calibration of the indicators into package performance zones.

This paper presents a number of research and development projects funded by the NDA's DRP to address monitoring and inspection needs of waste packages in interim storage. These needs were identified during a series of workshops held during the early stages of the IPT for Interim Storage.

2. Embedded Sensors using Inductive Coupling

2.1. Background

One of needs identified in the workshops was the requirement to obtain sensory information from the wasteform, either in the form of dummy waste packages or real waste packages. Due to the long timescales involved with interim storage, it would be beneficial to have no requirement for batteries. In

addition, to maintain containment of the waste packages it would be desirable to perform these measurements without the need for cables passing through the waste container. In terms of the industry guidance, a number of the potential indicators of evolutionary processes affecting the safety function of waste packages include: internal strain, internal properties and internal measurements

A University of Leeds, UK, spin out company, Instrumentel Ltd (www.instrumentel.com) has commercialised two-way Inductive Coupling Telemetry (ICT) as a means of obtaining sensory information from hostile and difficult to access environments without the needs for batteries or cables. Inductive coupling occurs when a coil generating an electromagnetic field is in proximity with a secondary coil into which electrical power is then induced. The development of ICT has led to the rapid development of Radio Frequency Identification (RFID) systems. RFID systems are passive in that they provide access to data such as an identification code but are not active in terms of sensing or interacting with their environment. The ICT system developed by Instrumentel allows two-directional near-field communications between the reader and tag, enabling the tag to interact with its environment and gather data from it through attached sensors. An ICT system consists of an electronic sensor tag, sensors and a reader which can interface with a PC for data download and analysis.

2.2. Wasteform Monitoring using Inductive Coupling Telemetry

Before beginning the experimental work, a desk top study was performed to ensure the introduction of this technology into a waste package would not be detrimental to the waste package. The NDA Radioactive Waste Management Directorate (RWMD) defines standards for UK nuclear sites conditioning and packaging Intermediate Level Waste (ILW). The RWMD advises site operators on how to package ILW through a formal Letter of Compliance (LoC) assessment process. The LoC assessment process aims to give confidence to site operators, regulators and stakeholders, that wastes are being conditioned into passively safe forms that would also be compatible with plans for the development of a GDF. Following discussions with RWMD it was identified that there were no show-stopping issues to the introduction of the technology into ILW waste packages, but RWMD would want to have visibility of the precise nature of proposals prior to them being implemented on real waste packages.

The current Instrumentel ICT used a reader emitting a carrier frequency of 13.56 MHz with a read range of less than 10 cm. It was predicted that the filter in the ILW container lid would further reduce the read range. A literature survey and experimental work was performed which identified that a carrier frequency of 125 kHz was optimal for providing sufficient power to the tag through the filter of the ILW waste container. Following the identification of a suitable frequency, the ICT system was re-engineered to provide the system elements needed for a proof of concept demonstrator.



Figure 1. (a) ICT fitted to underside of waste container lid (b) waste container with sensor harness being filled with reference grout

The ICT system and a sensor harness were fitted to a 500 litre ILW container at the NNL's Workington facility. Figure 1(a) shows the ICT system electronics attached to the underside of the lid (exposed green circuit board), with a strain gauge visible at the top of the photograph which responds to the lid being tightened on to the vessel. Less visible are a Platinum Resistance Thermometer (PRT) and a light sensitive sensor close to the ICT electronics. The wires shown in this figure lead to the various

sensors. Figure 1(b) shows a thermocouple on the side of the ILW container (fixed with green tape) and a strain gauge in a central position (supported by the wooden frame and again fixed in position with green tape).

In total there were seven sensors; three PRTs, three strain gauges and a light sensitive diode. The vessel was filled with a reference grout, lidded and left to cure. When a reader is moved into the vicinity of the lid vent measurements are collected from all seven sensors.

A further body of work was performed to demonstrate the radiation tolerance of the ICT system. Six of the original version of the Instrumental ICT system were deployed in a Gamma radiation test chamber for real-time data acquisition. Each tag was connected to a PRT. Three tags were exposed to a high radiation field with a cumulative dose of 11MGy which was estimated as the total dose associated with 100 years of interim storage and three tags were exposed to a lower dose. The tags acquired data from the PRTs and each tag was subject to a test function three times each day. There were some interruptions to data acquisition but these were unrelated to the health of the tags.

2.3. ICT Summary

It has been demonstrated that inductive coupling telemetry is:

- Compatible with the RWMD Letter of Compliance process which defines standards for conditioning and packaging nuclear waste
- Capable of operating within an ILW container filled with simulant waste
- Radiation tolerant to a certain degree (i.e. under accelerated conditions)

3. Inspection of Waste Package Lifting Features

3.1. Background

In terms of the industry guidance, one of the waste package safety functions is Handling. Conventional ultrasonic thickness gauges emit a sound wave into a material, typically a plate, and the wave is reflected from the back surface which provides a measurement of the plate thickness. Ultrasonic Phased Array probes consist of many small ultrasonic elements, each of which can be pulsed individually. By pulsing the elements one by one in sequence along a row, the ultrasound beam can be steered electronically through the item under investigation. The sound energy is introduced and propagates through the material in the form of waves. When there is a discontinuity (such as a crack) in the wave path, part of the energy will be reflected back from the flaw surface. The reflected wave signal is transformed into an electrical signal by the transducer and is displayed on an image. The University of Bristol NDT Group has expertise in ultrasonic phased arrays and partnered with NNL for this project.

3.2. Lifting Feature Inspection using Ultrasonic Phased Arrays

The project focused on a new design of 3 m³ box ILW waste container under development as several samples were available at the NNL's Workington Facility. Figure 2 shows a drawing of the lifting feature which is positioned at the four corners on the top of the container. A mock up of the lifting feature was machined at the University of Bristol to enable laboratory testing which demonstrated the ultrasound could be steered towards the region of interest – where the lifting feature is welded to the main waste container.

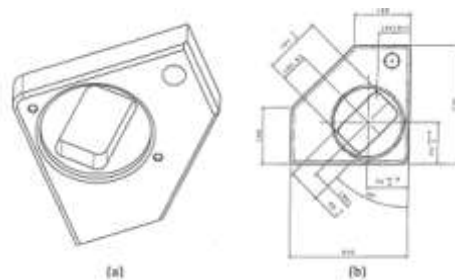

Figure 2. Lifting feature for the 3 m³ box ILW container

Following the successful measurements performed at the University of Bristol NDT Laboratory, inspection of the lifting features on a range of 3 m³ ILW containers containing stimulant waste was performed at NNL Workington. These containers had previously been drop tested on another project. Their material of construction was Duplex 2205 and it was necessary to correct all measurements for angular dependent velocity using software developed by the Bristol NDT Group.

The majority of lifting features were visually undamaged by the drop tests as shown in the photograph of Figure 3(a). In some cases the lifting feature was missing where the impact had been on the corner containing the lifting feature. In one case, the lifting feature was significantly damaged but still attached to the waste container as shown in the photograph of Figure 3(b).

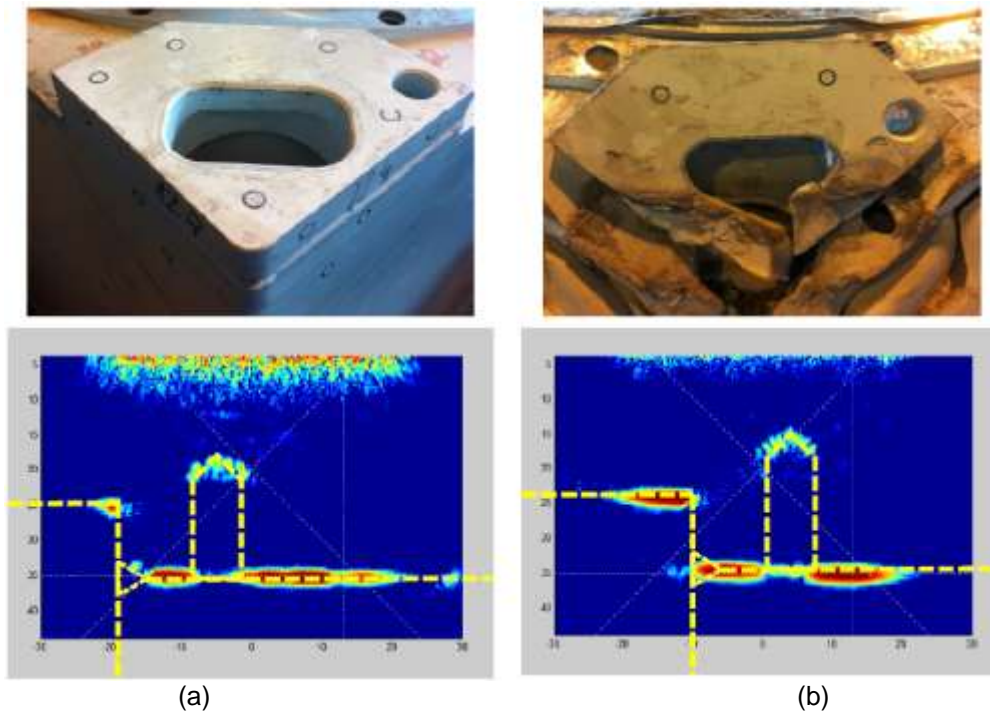

Figure 3. Photograph and ultrasonic image (a) defect free lifting feature and (b) failed lifting feature

Figure 3 shows ultrasonic images of the assumed defect free and failed weld lifting features with the numbers on the axes referring to the dimensions of the lifting feature in millimetres. In the case of the assumed defect free lifting feature the ultrasound passes through the weld. In the case of the failed weld lifting feature there is a large direct scatter from the whole of the back face. While this is not positive detection of a discrete failure this does illustrate that ultrasonic phased array would detect a fusion failure at the weld face.

3.3. Lifting Feature Inspection Summary

It has been demonstrated that ultrasonic phased arrays are capable of inspecting the weld region between a lifting feature and the main waste package container in an inactive environment where access to the waste package is possible.

4. Smart Corrosion Coupon

4.1. Background

One of needs identified in the workshops was the requirement to identify a technology which could replace or complement conventional corrosion coupons by providing a real-time measurement of corrosion. In terms of the industry guidance, the indicator 'direct measurement of corrosion' is linked to several safety functions; Containment, Identification, Handling, Stacking and Prevent over-pressurisation. The Field Signature Method (FSM) is designed to detect metal loss, cracking, pitting or grooving due to corrosion by detecting small changes in the way current flows through a metallic structure and is used extensively in the oil and gas sector. An array of electrodes is attached to the sample. Electric current is injected between two pins and voltage measurements are made between

other pairs of electrodes. It is a differential technique and measurements are compared against a signature measurement taken before any damage has occurred.

4.2. Development of a Smart Corrosion Coupon

Conventional applications of FSM include pipeline corrosion/ erosion monitoring where the technology is directly fitted to the asset i.e. the pipeline as shown in Figure 4(a). In this case, an array of electrodes has been fixed to a sample of material to match the material of ILW waste containers to produce the Smart Corrosion Coupon as shown schematically in Figure 4(b). It would also be possible to fit the technology to the interior of an ILW waste container to produce a dummy package with corrosion sensing over the entire external surface of the container.

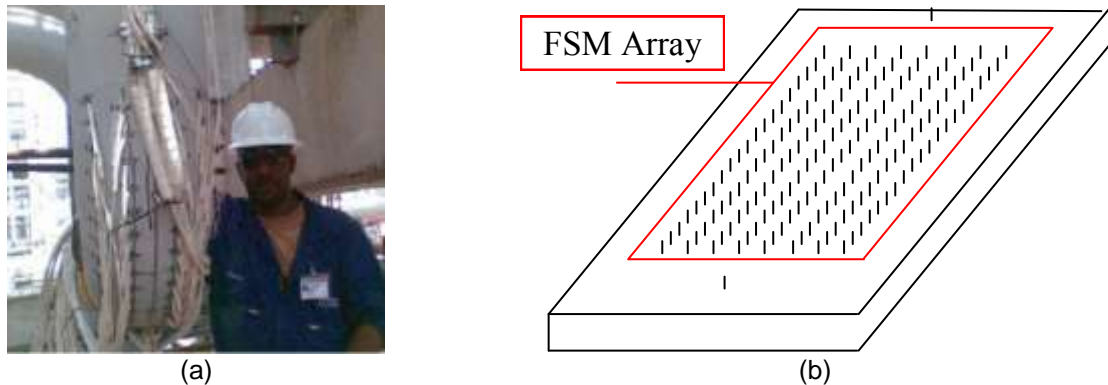

Figure 4. (a) FSM applied to a pipe bend and (b) FSM coupon concept

An experimental programme is planned; defects will be machined in a Smart coupon to test the sensitivity of the technology and accelerated corrosion trials are planned in an environmental chamber.

4.3. Smart Corrosion Coupon Summary

A Smart corrosion coupon has been constructed based on FSM technology. An experimental programme is due to commence shortly and the presentation may include results if these are available.

5. Conclusions

The recently published UK Industry Guidance on the interim storage of HAW packages establishes a method to define generic package performance criteria. The method consists of the following steps; identification of the package safety function, identification of evolutionary processes that may affect safety function performance, determination of measurable indicators of these evolutionary processes and calibration of the indicators into package performance zones. A monitoring and inspection approach is necessary to demonstrate that that safety functions are maintained over the lifetime of the package. This paper has highlighted three technologies which pending further development could be included in a toolkit of potential techniques, solutions or other options to promote robust package performance during interim storage.

6. Acknowledgements

Funding was provided by the Nuclear Decommissioning Authority's Direct Research Portfolio. The inductive coupling telemetry was provided by Instrumentel Ltd. The University of Bristol NDT research group provided the ultrasonic phased array technology and expertise.

7. References

1. Managing radioactive Waste Safely - A Framework for Implementing Geological Disposal, Cm 7386, June 2008.
2. Committee on Radioactive Waste Management, Interim Storage of Higher Activity Wastes and the Management of Spent Fuel, Plutonium and Uranium, CoRWM Doc 2500, March 2009.
3. Nuclear Decommissioning Authority, Interim Storage of Higher Activity Waste Packages – Integrated Approach, Industry Guidance, Draft Issue 2, September 2012

MANAGEMENT OF OPERATIONAL RADIOACTIVE WASTE FROM TRIGA RESEARCH REACTOR: A PRACTICAL SOLUTION FOR DISPOSAL

D. BUJOREANU, L.BUJOREANU, M. IORDACHE
*Waste Management Department, Institute for Nuclear Research
Str. Campului no 1, POB 78, Pitesti, Romania*

ABSTRACT

The Institute for Nuclear Research Pitesti (INR), part of the Autonomous Company for Nuclear Activities operates a 14MW TRIGA reactor that promotes research and development in the field of nuclear energy and radiation science and technology.

The radioactive waste generated by the operation of this research reactor is processed in the facilities of the Waste Treatment Plant from INR following the previous of the “Joint Convention on the Safety of Spent Fuel Management and on the Safety of Radioactive waste Management” following the Norms established by the National Authority for Nuclear Activities Control (CNCAN) regarding the disposal at National Repository Baita-Bihor.

The TRIGA reactor operations generate the following types of low level radioactive waste (LLW):

- Solid radioactive waste;
- Spent ion exchangers;
- Active β - γ liquid radioactive waste.

The conditioning process of radioactive waste resulted from operating the TRIGA reactor is done at the Radioactive Waste Treatment Plant of the Institute for Nuclear Research and it ensures that the quality assurance criteria are met for the waste packages final storage.

1. Introduction

The Institute for Nuclear Research Pitesti (INR), of the Autonomous Company for Nuclear Activities has its own Waste Management Department.

Among the most important practices that generate radioactive waste it shall be mentioned the operation of the TRIGA reactor, the operation of the Post Irradiation Examination Laboratory and waste resulted from research laboratories of INR.

The main purpose of processing radioactive waste is to produce a waste package that fulfils the acceptance requirements for disposal at National repository Baita-Bihor.

Waste shall be processed after its precise characterization and processing technology selected, to ensure the acceptance requirements for storage, transport and disposal in accordance with quality assurance program and international recommendations.

The product obtained after conditioning, is the assembly made up of metallic drum-concrete-radioactive waste and is stored at the storage facility of INR, until the package will be transported for disposal at National Repository for Low and Intermediate Radioactive Waste, Baita- Bihor.

2. Processing of waste from TRIGA reactor

The treatment and conditioning of operational waste from reactor, will normally be governed by the following factors:

- The quantity of waste to be processed;
- The physical, chemical and radiological waste characteristics;
- The possibility of segregation of the waste into acceptable categories, such as: combustible and non-combustible, compactable and non-compactable, and metallic and non-metallic;
- The condition of the waste packages, such as stability and reliability for further handling without spilling the waste;
- The availability of a final destination for the waste and of corresponding WAC.

The aim of applying treatment and conditioning techniques for processing of radioactive waste generated from TRIGA reactor is to obtain a waste product that can be disposed of more safely. A general processing scheme for operational radioactive waste from TRIGA reactor is given in Fig1.

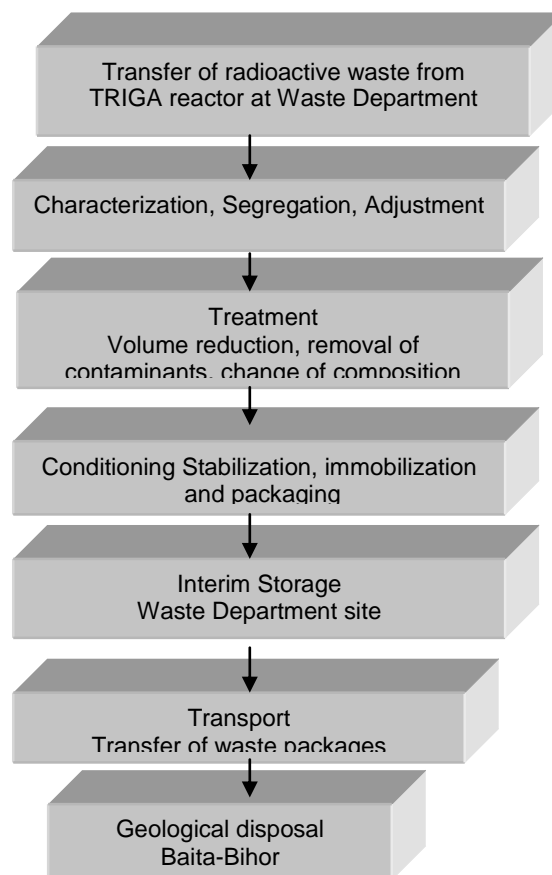

Fig.1 Simplified diagram of waste processing from TRIGA reactor

The main radioactive waste generated from TRIGA reactor operation are in general low level waste with activities under 10^{-3} Ci/m³ and that contained in special Co-58, C0-60, Mn-54, Cs-134 and Cs-137 radionuclides.

2.1 Solid waste

Solid radioactive waste are generally segregated into combustible, compactable and non-compactable forms, including protective clothing, plastic sheets, rubber gloves, towels, metal and glass and discarded equipment.

A typical composition of solid radioactive waste generated by the research reactor is:

- 80% compactable materials, subdivided into plastic, paper and clothes;
- 20% materials non-compactable such a metallic or glass objects.

Treatments of solid waste not combustible or compactable are segmentation in order types of disposal container can be used.

The cementation conditioning procedure for disposal was elaborated by the Waste Department of INR Pitesti.

The product obtained after conditioning, is the assembly made up of metallic drum-concrete-radioactive wastes (Fig 2) and was tested in correspondence with Standard number 012 / 1994, by the Reliability and Testing Laboratory of INR Pitesti. The test conditions for final disposal include: impact, puncture, free drop test and penetration [1].



Fig 2. 200l package with solid waste

2.2 Bituminization of spent ion exchange resin

Management of spent resin waste generated from water purification system of TRIGA reactor comprises different operation such as pretreatment, treatment and conditioning, using a technology for stabilization of waste in bitumen and containerization into 200l metallic drum suitable for handling, transport, storage and to cover the criteria for acceptance at disposal site.

The parameters which influence the good progress of the process and also the quality of the final product are: the bitumen type, the bitumen / resin embedding ratio, bituminization temperature, mixing time and the results of the qualification tests of the package for disposal.

The flow diagram of bituminization process is given in Fig. 3 and a package with bituminization resin for disposal is presented in Fig.4.

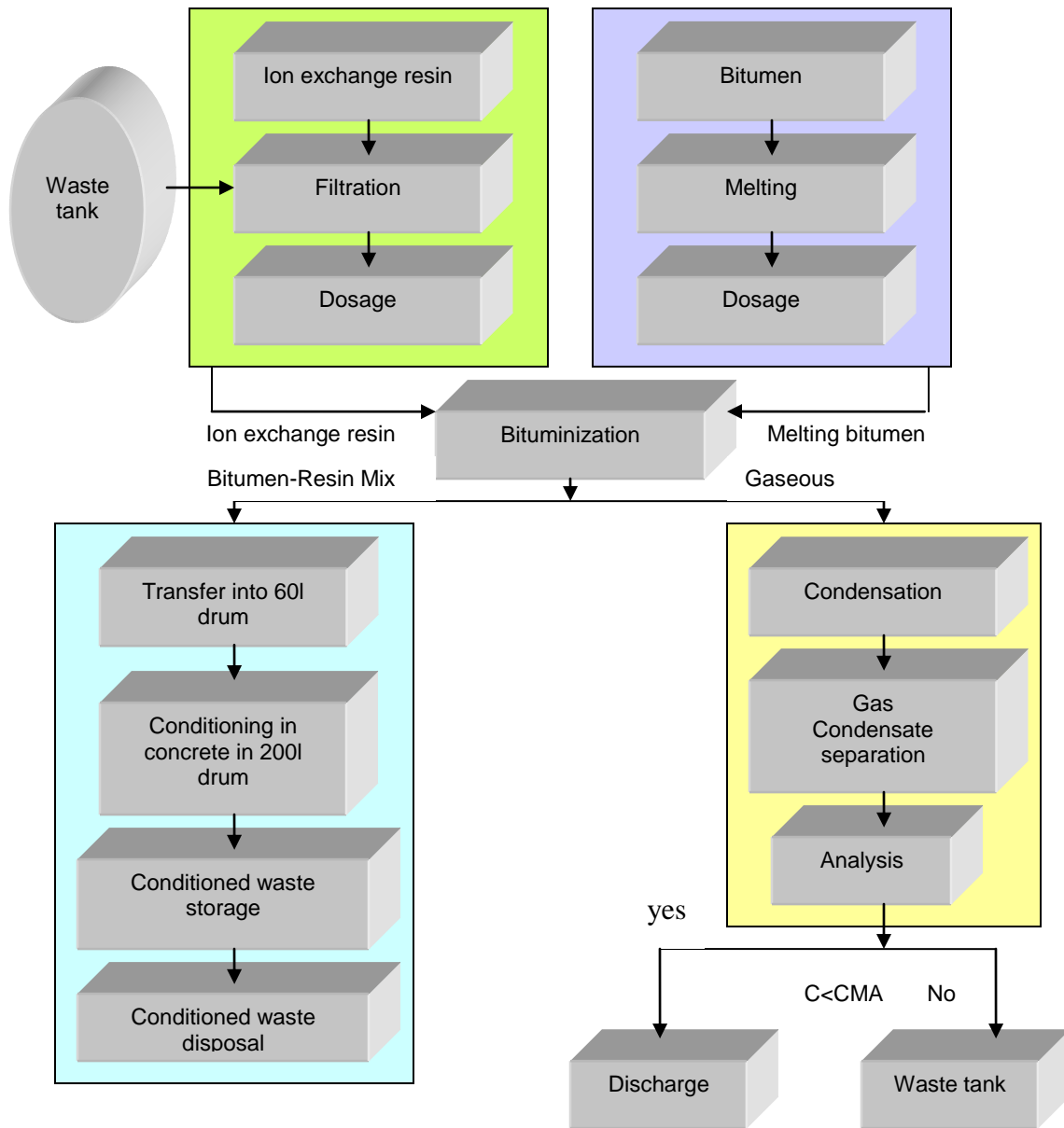

Fig 3. Flow diagram of the separated in-drum bituminization / cementation process



Fig 4. 200l package with conditioned resin waste

2.3 Liquid waste

There are various options for the treatment of liquid radioactive waste that depend on the chemical and radiochemical properties. At Waste Department, the liquid waste from TRIGA reactor is processed within evaporation.

The evaporation system processes liquid wastes has a maximum activity of 10^{-3} Ci/m³ into radioactive concentrates (maximum activity 1 Ci/m³) and normal water distillates. The evaporator unit is a KESTNER evaporator with 2 m³/h operating capacity and is designed to reduce the waste volume in a maximum ratio of 50 : 1 depending on the initial salinity.

Concentrates arising from the treatment of liquid radioactive waste are immobilized into 200l metallic drum to produce a stable, solid waste form [2].

The distillate from evaporation is analyzed before its discharge into the industrial water drain.

Into figure 5 is presented the technological diagram for conditioning of evaporator concentrates.

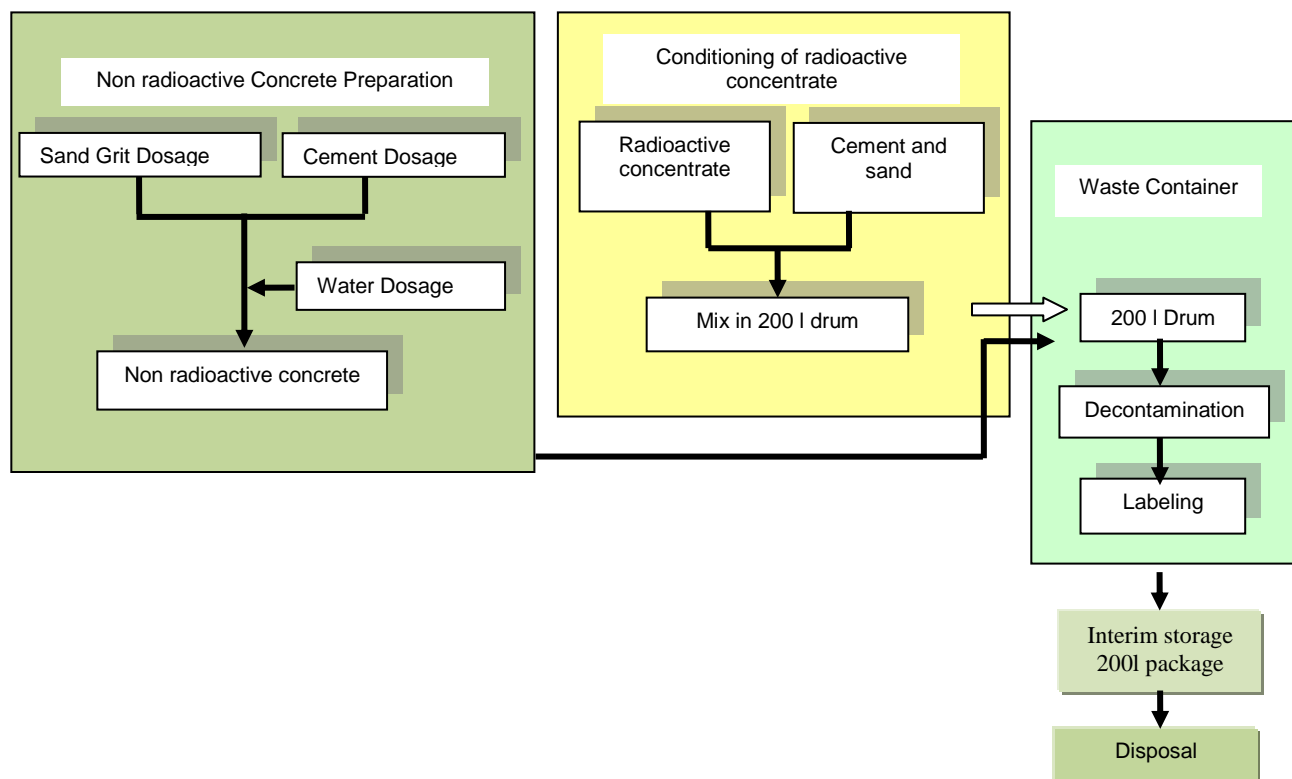

Fig 5. Technological flux for conditioning of concentrate from evaporator

3. Safety of radioactive waste management

The generation of radioactive waste resulting from TRIGA reactor is kept to the minimum practicable, both in activity and in volume and radioactive exposure of the operating staff during processing and storage is maintained as low as reasonably achievable-ALARA.

Some of the International convention could be relevant on the decision of waste management:

- The Joint Convention on the Safety of Spent Fuel Management and on the Safety of Radioactive Waste Management [5];
- The Convention on Environmental Impact Assessment in a Transboundary Context (the Espoo Convention) [6].

The contamination control, temporary accumulation and storage a radioactive waste within Waste Management Department are measurement and assessment using:

- Direct beta measurement;
- Direct gamma dose rate;
- Radiochemical analysis;
- Lichid scintilation counting;
- Gamma spectroscopy.

4. Considerations for the storage and disposal of immobilized radioactive waste from TRIGA reactor

In view of the conditioning of waste generated from TRIGA reactor operation and maintenance it is necessary to establish clarity on the final waste form and final destination of the conditioned waste.

Romania has established WAC that allows low and intermediate radioactive waste to be conditioned for disposal.

This allows to Waste Department from INR to condition the waste into its final form that will be acceptable at the National Repository Baita-Bihor.

The final product, resulted after containment in concrete of the waste in 200l drum is called the "Assembly drum-concrete-low-active waste" (ABBD-1) under the form of a monolithically concrete cylinder.

The waste form and package are determined by acceptance criteria that including security tests and physical protection are established by the competent authority, in our case the Romanian National Commission for Nuclear Activities Control for the final disposal.

The process parameters which affect the quality of the final product are standardized and comply with the following acceptance criteria for waste packages:

- Each waste package will contain only one type of waste;
- The maximum content of radionuclide contained (maximum admitted activity) will be in accordance with the criteria for final disposal at the National repository (Table 1);
- The contamination at the 200 l drum outer surface should not exceed 4 Bq/cm²;
- The surface exposure rate of steel drum must be less than 2mSv/h;
- The determined lixiviation rate must be of maximum 10⁻³ cm/day.

Tab 1: Maximum admitted activity for packages disposal at DNDR-Baita Bihor

Radionuclide	Maximum admitted activity (Bq/m ³)	Maximum admitted activity (Bq/200 l metallic drum)
Cs-137	1 · 10 ¹⁰	2 · 10 ⁹
Cs-134	5 · 10 ¹¹	10 · 10 ¹⁰
Co-60	3 · 10 ¹¹	6 · 10 ¹⁰
Co-58	5 · 10 ¹¹	10 · 10 ¹⁰
Co-57	5 · 10 ¹¹	10 · 10 ¹⁰
Mn-54	5 · 10 ¹¹	10 · 10 ¹⁰

5. Conclusions

According to the Low on the safe deployment of nuclear activities [4], the objective of Romanian radioactive waste management policy is to assure the nuclear safety conditions set for the protection of the professionally exposed personnel, of the population and of the environment, with minimal risk provided by regulations and IAEA requirements [3].

Conditioning of radioactive waste from TRIGA reactor operation, which contain Mn-54, Co-57, Co-58, Co-60, Cs-134 and Cs-137 radionuclides implies their embedding into a structure so that

the resulting products be accepted as solid monoliths with physical and chemical properties that provide their integrity during handling, transport and storage as well as a long-term stability, depending on the type of the repository.

In view of the conditioning of these wastes, the Waste Department from INR Pitesti licensed a conditioning technology that makes the final product, intended for disposal at the National Repository Baita-Bihor, display radiolytical, mechanical and chemical stability, allowing it to maintain long term integrity, while pollution ranges within the limits allowed by the Romanian law in force.

The final product, resulted after containment in concrete of the waste in 200l drum is called the "Assembly drum-concrete-low-active waste" (ABBD-1) under the form of a monolithically concrete cylinder. The whole assembly is produced in compliance with the licensed technology regarding low-active wastes, so that the requirements of the National Commission for Nuclear Activities Control are fully met.

The final product, after treating and conditioning, is the assembly metallic drum-concrete-radioactive wastes (type A package), which is disposed of at the National Repository Baita, Bihor.

The waste form and package are determined by acceptance criteria that including security tests and physical protection are established by the competent authority, in our case the Romanian National Commission for Nuclear Activities Control (CNCAN) for the final disposal in the National Repository Baita, Bihor.

6. References

- [1] I.V. Popescu, D. Bujoreanu, Assembly metallic drum-concrete-radioactive wastes (ABBD-1), SF-ICN –012/1994, ICN Pitesti, Romania, Ed.3/2003;
- [2] Technical Reports Series no. 350- Improved Cement Solidification of Low and Intermediate Level Radioactive Wastes, IAEA, Vienna, 1993;
- [3] Safety Standards Series No. GS-R-1, Legal and Governmental Infrastructure for Nuclear, Radiation, Radioactive Waste and Transport Safety-REQUIREMENTS, IAEA, Vienna, 2000.
- [4] Law on the safe deployment of nuclear activities, Bucharest, 2004;
- [5] Joint Convention on the Safety of Spent Fuel Management and on the Safety of radioactive Waste Management, INFCIRC/546, IAEA, Vienna (1997);
- [6] Convention on Environmental Impact Assessment in a Transboundary Context, UN Economic Commission for Europe, Espoo (1991).

CHALLENGES OF WASTE MANAGEMENT FROM LEU BASED Mo99 PRODUCTION

DJAROT S. WISNUBROTO

*National Nuclear Energy Agency of Indonesia (BATAN)
Kuningan Barat – mampang Prapatan, Jakarta, Indonesia, 12710*

ABSTRACT

Nuclear security that resulted in limited/restricted raw material of high-enriched uranium (HEU) UO_2 are the basic reasons to convert the Mo-99 production to low enriched uranium (LEU) and encourage new LEU-based production. So, challenges likely to arise, and waste management is one of them. There is an issue of increased wastes with the use of LEU targets. Although, may be no significant change to liquid or other solid waste streams and no criticality issues, but there are changes on the doubling of uranium mass and increase in activity of actinides. When the domestic and international demand of Mo99 increases, so the waste management must be calculated carefully, and there will be various wastes such as spent uranium, including actinides and fission products, with the form of liquid and solid must be treated. This is a challenge for BATAN to resolve that situation.

1. INTRODUCTION

Since 1996 Indonesia had produced Mo-99 from HEU fission product mainly for domestic consumption. This Mo-99 production uses electroplating technology[1]. However, due to limited and restricted raw material of HEU, Indonesia has a conversion program from HEU to LEU for producing Mo-99 from LEU foil target. The substitution of low enriched uranium (LEU) metal foils for the HEU UO_2 used in current target designs will be applied for production of Mo-99 commercially. Batan has a joint research project with ANL to develop LEU-metal-foil target fabrication since 1992. Many achievements have been resulted from the experiments. ANL has developed several of LEU target design and fabrication, and has been demonstrated in Radio Metallurgy Installation hot cell in Batan for disassembly process to take out LEU foil from the target after being irradiated in reactor RSG-GAS BATAN. Chemical processing was conducted in Isotope Production Centre hot cell for producing Mo-99 which will be used to produce Tc-99m Generator. The experiment was terminated temporary in 2004 due to September eleven accident. In November 2005, ANL provided training LEU target assembly to BATAN by simulation of Cu-foil as LEU foil. And then BATAN personnel demonstrated reassembly of 2 ANL LEU targets to replace Zn and Al foil barrier with Ni foil barrier in January 2006. Good coordination work had been conducted by BATAN, ANL and IAEA for CRP workshop on LEU foil target at Serpong in March 2006. All of these activities are for preparing Indonesia to change the production of Mo-99 from HEU fission product to LEU fission product. The conclusion, with respect to the significant efforts undertaken by BATAN in cooperation with ANL and the on-going IAEA CRP, LEU foil target fabrication technology is ready for commercial production[2]. One of the primary considerations for using this method is converting the dissolver solution to nitric acid alone, means facilitating waste treatment and disposal. Sulphate in the acidic waste solution from the Mo-99 recovery step complicates uranium recovery, waste volume reduction, and waste disposal. Therefore, removal of sulphuric acid from the dissolver solution is likely to significantly reduce total processing costs.

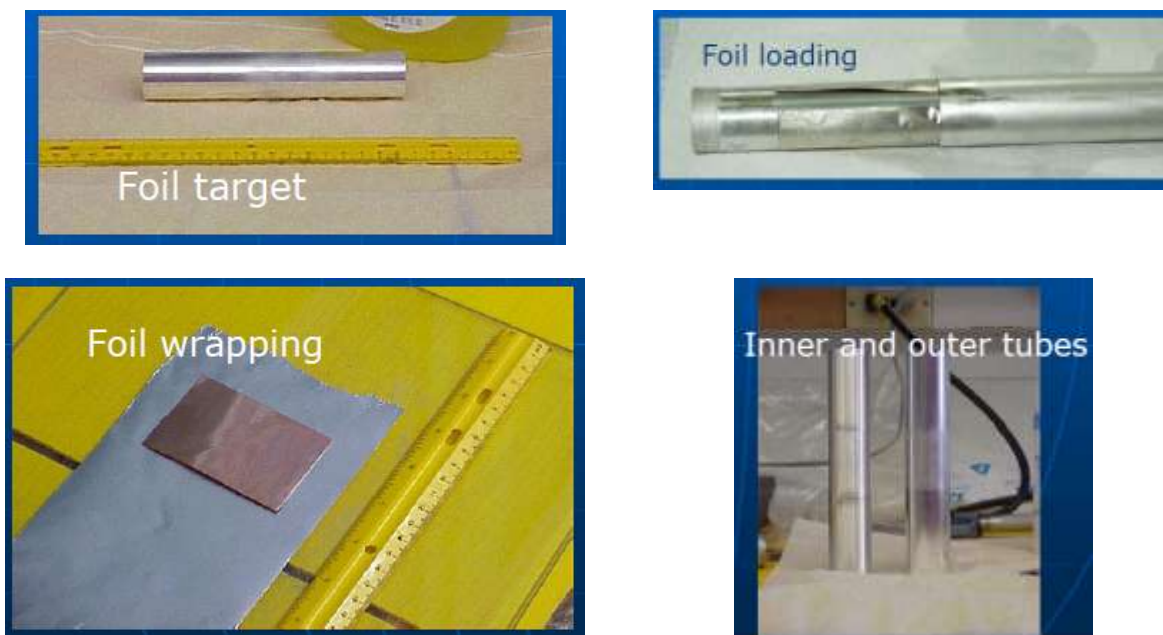

Figure 1. LEU Target Fabrication

Table 1. Production of Mo-99 using HEU based on the electroplating technology.

Year	1996	1997	1998	1999	2000	2001	2002	2003	2004	2005	2006
Mo-99, Ci	300	1775	2002	1746	783	140	420	806	1550	1575	1786

However, as the research and development organization, BATAN is prohibited to produce commercially Mo-99, then the state owned company called PT Batan Technology should do this. However due to the economical reason they reluctant to use foil target method, and tend to use the previous electroplating method for LEU target since November 2011. Safety aspect of using electroplating for the LEU target now is under discussion in BATAN. PT. Batan Technology supply the domestic demand, and also exporting the product to neighbouring countries such as Malaysia, Bangladesh and other countries. According to their report, the recent capacity of production is around 200-900 Ci/w.

At present most Mo-99 is produced by means of the fission of U-235, as this is still the only proven process for the production of large quantities of Mo-99 with very high specific activity. For this reason most of the available information pertains to waste from fission Mo-99 production. This waste is also the most difficult to handle due to the presence of fission products.

By recent change from using HEU to LEU, then the largest change to the waste streams are:

- Doubling of uranium mass (to keep U235 mass the same)
- Increase in activity of actinides
- No significant change to liquid or other solid waste streams
- No criticality issues
- Increase in the volumes of waste per curie 99Mo produced.

2. Modification of Radioactive Waste Management in Indonesia

At the present time, The Radioactive Waste Technology Centre (RWTC) BATAN is the only institution in Indonesia that has capabilities to treat radioactive waste in the forms of liquid, spent resin, combustible waste, high active waste, and sealed source. RWTC is equipped with evaporator, compactor, incinerator, chemical treatment, conditioning facilities for spent sources and also interim storage and quite recently been assigned to be responsible to manage the interim storage for spent fuel from the adjacent MTR type research reactor. The flow for treatment of radioactive waste is described below.

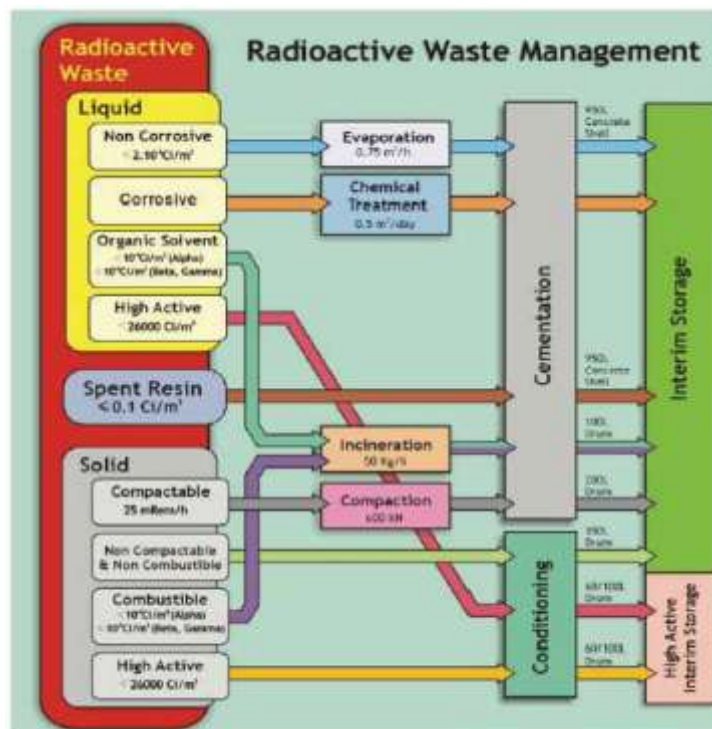

Figure 2. Current radioactive waste treated in BATAN

Although Mo-99 has been produced since 1996 (16 years ago) however most of the radioactive wastes are still stored in the production location, and steps by steps will be transferred to RWTC BATAN. Small numbers were sending back to the United States. As known, since May 1996 United State Department of Energy (US DOE) through Record of Decision (ROD) for the Final Environmental Impact Statement (FEIS) on a Proposed Nuclear Weapon Non-proliferation Policy opened opportunity to all research reactor owners to send back their SNF and uranium target of US Origin to the United States.

PT. Batan Technology has already sent general data of their waste, i.e. the total amount of solid and liquid waste are 52 drums 100L, and the liquid volume is about 100m³ containing fission products (Cs-137) and uranium. The problems are, the RWTC lack of experiences how to handle the waste that contains uranium, actinides and fission products in liquid form, and also lack of facilities and technologies to handle that waste. Consideration at the moment to store the waste inside interim storage for low level waste and at the high active temporary waste storage for the higher activity.



Interim Storage



High active waste storage

Figure 3. Waste storage facilities in BATAN

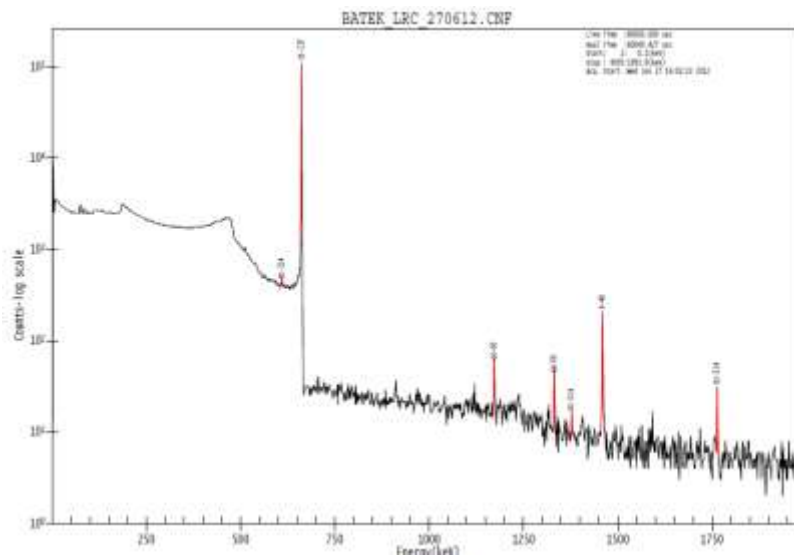

Figure 4. Spectrograph of liquid waste from Mo-99 production.

Table 2. The specific Activities (Bq/L) of elements in the liquid waste

K-40	94,97 ± 13,91
Co-60	4,81 ± 0,43
Cs-137	5727,30 ± 174,31

BATAN expect the radioactive waste from Mo-99 production will increase significantly due to the growing demand of this radioisotops in the region. However, a special method for treatment of the waste must be applied, since space of interim storage is limited.

At present, the government has a regulation on the waste management fee. It means that every waste generator must pay to the government amount of money for the waste management in BATAN. However the tariff that has been established is only based on the treatment and temporary storage, without considering the disposal activities [3].

3. Other Challenges

Isotope prices are currently not covering operating or capital costs. Processing costs and prices seem to be more sustainable but only because reactor costs are absorbed by governments. Or in other words, market prices are not yet subject to the discipline of proper

cost recovery at all stages of production, and there is currently no agreed mechanism to charge for waste management. Radioisotope production needs to be seen as step in a pharmaceutical value, rather than something “good” that the nuclear industry does. There has to be a long term commitment in the industry and in the IAEA to achieve realistic pricing, and to impose penalties on companies and countries that cross-subsidize. BATAN, in the long term, takes the view that responsible and sustainable nuclear medicine production should include a costing approach that includes the disposition of wastes from the processing of Mo-99.

4. References

1. **ZAHIRRUDIN**, Production of Mo-99 Radioisotopes from U-235 Fission Product and Its Safety Aspect, Seminar on Safety and Technology of Nuclear Power Plant, BATAN, Serpong, 9-10 February 1993
2. **B. BRIYATMOKO**, et al., Indonesia’s Current Status for Conversion of Mo-99 Production to LEU Fission, International RERTR Meeting 2007, Prague, Czech Republic, 23-27 September 2007
3. **DS Wisnubroto**, “Analysis of The Institutional Framework for Radioactive Waste Management in Indonesia”, Atom Indonesia, Vol. 35, No. 2, July 2009, ISSN 0126-1568, pp. 7-20

SLOVAK BENTONITES AS ENGINEERING BARRIERS IN RADIOACTIVE WASTE MANAGEMENT

A. KRAJŇÁK, M. GALAMBOŠ, O. ROSSKOPFOVÁ, E. VIGLAŠOVÁ, P. RAJEC
*Comenius University in Bratislava, Faculty of Natural Sciences, Department of Nuclear Chemistry
Mlynská dolina, 842 15 Bratislava, Slovak Republic*

ABSTRACT

In our work we described the mineralogical, physico-chemical and physico-mechanical properties of Slovak bentonites and the study of their behaviour in the presence of factors within environmental conditions expected in the deep geological repository. Bentonites belong to a group of natural nanomaterials with significant ratio of dioctahedral smectite - montmorillonite. Slovak Republic avails of many significant deposits of bentonites (Dolná Ves, Jelšový potok, Kopernica, Lastovce, Lieskovec). For the experiment we have chosen batch techniques and the method of radioisotope indication. The result of our work was a comprehensive study of adsorption processed for selected products of ecotoxic significant fission products of uranium (Sr-90, Cs-137) in the bentonite barrier. Bentonites from the Slovak deposits (Jelšový potok, Kopernica, Lastovce, Lieskovec) meet most of the geotechnical requirements for that type of barriers. They can be used as filler, damping, respectively sealants materials in the vicinity of a container for radioactive waste and spent nuclear fuel. Smectite bentonites jastrabská formation – Jelšový potok and Kopernica was identified as the most suitable material for practical using in deposition of high-level radioactive waste and spent nuclear fuel. Bentonites of these deposits are stable material guarantees a long-term stability.

1. Introduction

To maintain the position of nuclear energy in Europe's energy mix and in all countries of the world is necessary for professionals and for the public in general, to ensure the maximum environmental protection, including full control of the high-level radioactive waste (HLRW) and spent nuclear fuel (SNF) from nuclear power facilities. Significant producers of HLRW and SNF in Slovak Republic are nuclear power plants located in Bohunice and Mochovce. These plants currently operate with four reactors of type VVER 440. Two reactors of the same type are under construction in NPP Mochovce. It is assumed that blocks of individual nuclear power plants in Slovakia will produce during their project operation period 2 500 t of SNF and 3 700 t of RW. This amount of waste in under the current legislation will not be able to be deposited in the Mochovce in surface type of Republic Repository of Radioactive Waste, but it will have to be deposited in a deep geological repository (DGR). In the future Slovakia will probably continue in the peaceful uses of nuclear power and in the associated construction of additional energy sources in potential locations Bohunice and Kecerovce.

2. Deep geological repository development in Slovakia

The preparatory and development work on building DGR in Slovakia began in 1996 [1]. DGR should be placed below the ground surface in a stable geological formation, which will form one of the most important barriers of a multi-barrier system (a combination of technical and natural barriers, i.e. geological barrier) [2]. The role of geological barrier as a longest-acting one in the multi-barrier system of repository protection is to isolate the surrounding environment from harmful effects of radiation [3, 4]. Slovak DGR should be put into operation no later than 2037. According to preliminary evaluation of existing geological data have been identified 12 potentially suitable territories for DGR. Further evaluation led to a reduction of this number to 5 territories in two potential host environments (granitoids and sediments) that have been proposed for more detailed research: Tribec Mts., Veporske vrchy Mts., Stolické vrchy Mts., Rimavska kotlina Basin, Cerova vrchovina Upland (Fig. 1). Preparation of models

of potentially suitable localities for DGR placement includes extensive multidisciplinary research of interactions between host environment and engineering barriers [5-9].



Fig. 1 Simplified topographic sketch of Slovak part of Western Carpathian. Status of deep geological repository siting in 2004

3. Bentonite rocks

Bentonites are a group of natural nanomaterials composed predominantly of crystalline mineral particles from the group of dioctahedral smectites – montmorillonite. Bentonites from Slovak deposits should be used as part of multi-barrier system in DGR for SNF and HLRW [4]. The use of bentonite rocks or bentonite backfills in the repository is destined to their mineralogical, erosion and rheological properties, and in their favourable adsorption and retardation behaviour to the activation and corrosion products and the fission products of U [10-12]. Study of those products is the subject of still ongoing research. Adsorption properties of bentonites are determined by their chemical and mineralogical composition, value of cation exchange capacity and specific surface area. Slovak bentonites are subjected to basic and applied research for several decades.

4. Bentonite deposits in Slovakia

In the Slovak Republic are several important bentonite deposits [4, 13] (Fig. 1). There is the most popular and long mined bentonite deposit formed by Al-Mg-montmorillonite in the Slovak upland in the locality Stará Kremnička: *Jelšový potok*. In this area is one more a partially mined deposit of andesitic bentonite formed by Fe-montmorillonite: *Lieskovec*. In the eastern neovolcanic area, are two currently mined deposits of rhyolitic bentonites: *Kuzmice* and *Lastovce* (Al-Mg-montmorillonite). Also, in this area are currently not mined deposits Nižný Hrabovec, Fintice, Nižný Žipov, Veľaty and Hliník. Genetically are these deposits partly different, even though their common essential characteristic is that they arose as a product of volcanic activity and by subsequent action of alternating processes.

5. Performance requirements for bentonite barriers

The utilization of bentonites in multi-barrier system inevitably requires assessing a long-term stability of bentonite barrier behaviour, to characterize it from various geotechnical and physico-chemical aspects [3, 4, 14-17]. The our focus is on mineralogical properties such as mineralogical composition, the presence of hazardous materials (K-feldspar and biotite, calcite, anthropogenic carbonates), physico-chemical properties (chemical composition, cation exchange capacity, adsorption and retardation properties, radiation stability) and physico-mechanical properties (specific surface area, grain size).

6. Adsorption properties

The properties of natural, chemically modified and irradiated forms from the above-mentioned five Slovak deposits (*J, K, L, LA, DV*) were studied and compared [4, 15, 20-29].

The fractions of bentonites grounded under 15, 45 and 250 μm were monitored. Adsorption of Cs/Sr on the samples was studied through radioisotope indication using radioisotope of $^{137}\text{Cs}/^{85}\text{Sr}$ in static arrangement of experiment, in aerobic conditions at laboratory temperature. Radioactivity determination solution was done with spectrometer using NaI(Tl) detector. The statistical error of the measurement was below 1 %.

Adsorption of radionuclides ^{137}Cs and ^{85}Sr on bentonites is relatively quick [4, 13, 18-24]. The equilibrium of the bentonite sample **J** was reached almost immediately, within one minute from the beginning of the contact between solid and liquid phase (Fig. 2). Comparable values of distribution coefficients (K_d) and adsorption percentage (R) were obtained at interval of 1 to 480 minutes. Almost "instantaneous" capture of the Cs and Sr ions on the bentonite can be explained by adsorption and/or ions exchange with some ions on the basal surface and edge sites of the bentonite. The sharp increase of the adsorption percentage at pH 6 can be due to hydrolytic sorption by ion exchange in consequence of the reaction between the $\text{Sr}(\text{OH})^+$ and OH^- groups on the surface of the adsorbent and in lower concentration of competitive H^+ ions for sorption sites as well. In the systems open atmosphere and above pH 7, some of the Sr^{2+} uptake could also be described with the precipitation of SrCO_3 on the bentonite surface.

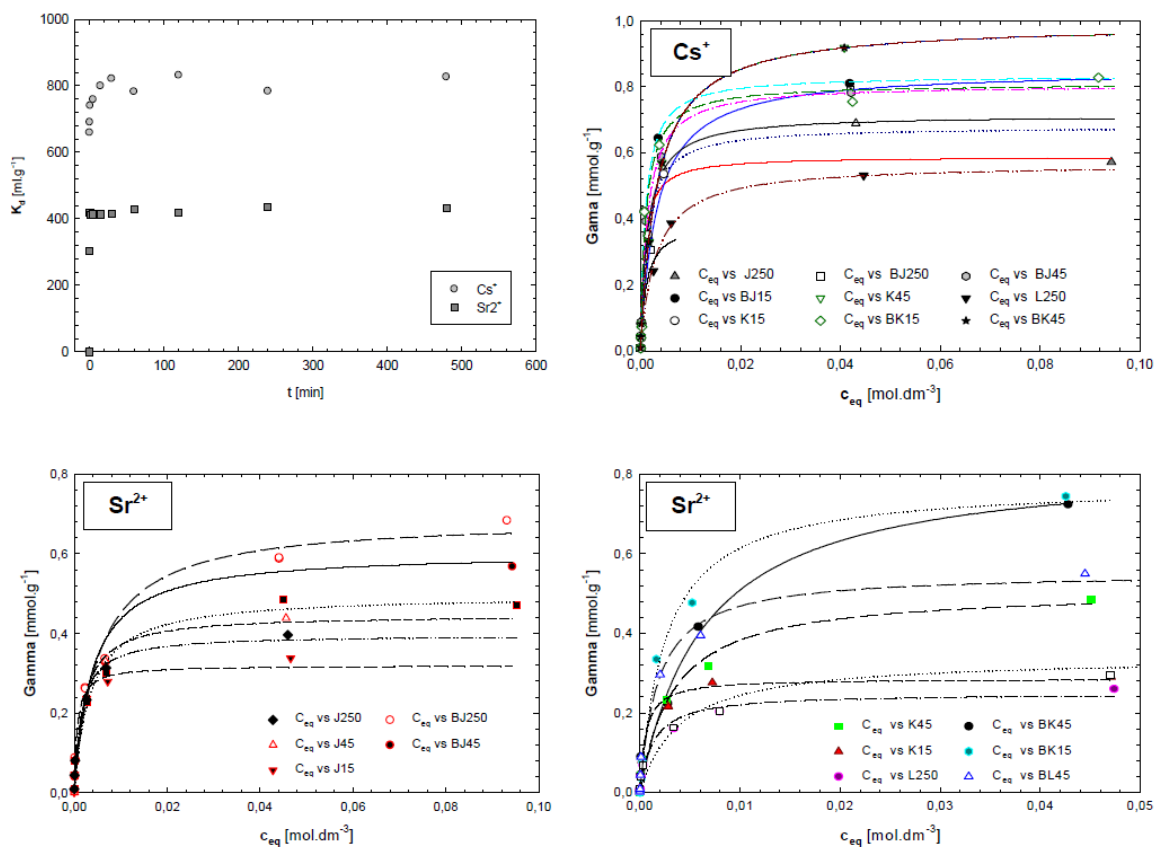

Fig. 2 Adsorption kinetics and modelled Langmuir isotherms for Cs-/Sr-adsorption

The changes in the pH of environment may occur in the deep environment [19-21]. The effect of the pH value change on the Sr-adsorption in the values range from pH 2 to pH 8, in various rates of solid (bentonites **J**, **K** and **L**) and liquid phase (8 different concentrations of Sr) confirmed, that the adsorption of Sr decreases in the order: pH = 8 > pH = 6 > pH = 4 > pH = 2. The values of R and K_d rates increase with increasing pH value (towards the alkaline area also with decreasing initial concentration of Sr in the solution). The value of R close to 99 % was reached on the adsorption of Sr-cations on bentonites **J**, **K** and **L** from pH = 8. From above it can be concluded that in addition to the basic adsorption mechanism, which is cationic exchange, there are processing at higher pH values the complexing reactions with surface groups of bentonite. The increase of the R value can be attributed to "hydrolytic" adsorption, because of the reaction between $\text{Sr}(\text{OH})^+$ and OH^- groups and competition of H^+

ion is suppressed. At pH = 2 there is interval of concentrations observed at low values of R , K_d and Γ (adsorbed amount) of strontium, which is attributable to significant competitive effect of hydrogen ions and disturbed bentonite structure.

High demands are placed on the radiation stability of bentonite barrier because the bentonites will be exposed to the long-term, continuous and immediate effects of ionizing radiation [18, 19]. The initial surface dose rates from γ -ray and neutron radiation are estimated at around $2 \text{ Gy}\cdot\text{h}^{-1}$. The interaction effect of ionizing radiation on the bentonites from **J** and **L** deposit, have been studied after sample irradiation by cobalt source (^{60}Co) with energy of 1.17 and 1.33 MeV for a period of about 50 days, with a moderate dose rate of $0.092 \text{ Gy}\cdot\text{s}^{-1}$ [18, 19]. Total absorbed dose was 390 kGy. At the irradiated samples of bentonites **J250** and **L250** there were detected higher Γ of Cs and Sr than at their non-irradiated forms. Currently there is being conducted a research of Cs and Sr adsorption on bentonites from 5 Slovak deposits (**J**, **K**, **L**, **LA**, **DV**), that were irradiated in a wider range of doses by γ -source ^{60}Co with the highest reached dose of 1 MGy [22]. The EPR spectra of bentonites from deposits **J** and **L** with absorbed doses of 10^4 and 10^5 Gy γ -rays showed no changes in the structure of the studied Slovak bentonites. The changes, which in terms of structure destabilization can be considered insignificant, occurred only in bentonites with absorbed doses of γ -radiation as much as 1 MGy. The absorbed dose of 1 MGy γ -radiation did not have an effect on the adsorption of cesium on every studied bentonite. Changes that can also be regarded as insignificant occurred only during strontium adsorption, especially on Fe-bentonite from deposit **L** and Ca-Mg-bentonite from deposit **J**, when an increase in the adsorption capacity occurred. Attention should be paid in further research of this topic which would require carrying out experiments on bentonite samples with absorbed doses higher by several orders of magnitude.

Metal cations, which may be present in groundwater, significantly affect the adsorption of radionuclides [18-21]. The effect can be explained by ion-exchange competing reactions and occupying the active adsorption centres of bentonites by other ions. The adsorption is suppressed more by the presence of bivalent cations than by univalent cations. The cause of the different observed effect is in bentonite ability to prefer cations with low hydration energy and small ionic radius. They preferably come into their inter-layer. According to the received ion size the distance between the layers varies. Smectite inter-layer increases its size by the ion, which is into its structure received. After losing the received ion the structure is changed again. This unique property – expandability is characteristic only for smectites and partially for vermiculites. The effect of competing cations (Na^+ , K^+ , NH_4^+ , Ca^{2+} , Ba^{2+} , Mg^{2+}) on the Cs and Sr adsorption confirmed, that the higher K_d values are achieved in the presence of univalent as well in the presence of bivalent cations. Values of the K_d increase with decreasing initial concentration of competing cations in the solution. The Sr-adsorption is the most suppressed by the presence of Ba^{2+} cation.

Organic compounds such as EDTA, oxalic and citric acid, humic acids and fulvic acids that are the part of the decontamination solutions or are ranked among the organic components of soil and water suppress the adsorption of radionuclides [21]. The effect of EDTA, oxalic and citric acids on adsorption of Cs has been studied in the concentration interval of 1×10^{-5} – $5\times 10^{-2} \text{ mol}\cdot\text{L}^{-1}$. The results confirmed that the presence of the studied organic and natural ligands significantly affects the adsorption of Cs. By increasing their initial concentration the values of R and K_d rates drop. The adsorption of Cs on samples **J15**, **K15** and **L15** is significantly suppressed at the ligand concentration of $5\times 10^{-2} \text{ mol}\cdot\text{L}^{-1}$: EDTA > citric acid > oxalic acid. The adsorption reducing effect can be explained by formation of soluble complex ions, which are too large for enter in the available structural positions of bentonite.

7. Conclusion

The results of this work suggest that Slovak bentonites from **Jelšovský potok**, **Kopernica**, **Lastovce** and **Lieskovec** deposits have satisfactory adsorption properties for cesium and strontium. The deposit **Dolná Ves** showed the lack of geochemical, especially adsorption and retarder properties of bentonite. The majority of models for the future deposition of radioactive waste and spent nuclear fuel prefer the deposition in metal or steel

containers, that would be surrounded by bentonite barrier. For to predict the long term stability of the bentonite barriers related to the deep geological repositories, is important to study the bentonite-metallic-Fe and bentonite-host rock interactions. Previous studies focused on iron/bentonite interactions showed a partial destabilization of the smectite structure [7, 8]. Bentonites containing Fe-rich smectites were the least stable during the reaction with metallic iron. It implies that the bentonite barrier at the contact with iron canister in a nuclear waste repository should consist of bentonite containing a minimal amount of Fe-smectite. Therefore we do not suggest using the **Lieskovec** bentonite to store the radioactive waste and spent nuclear fuel. The **Lieskovec** bentonite may find the utilization in the other, no less important, environmental applications. The bentonite from Stará Kremnička – **Jelšový potok** deposit is one of the highest quality bentonite in Europe. It is appropriate for the application in multi-barrier system of deep geological repositories for high-level radioactive waste and spent nuclear fuel.

8. References

- [1] Slaninka I. et al. (2007) Status and development of deep geological repository in Slovak republic from geological point of view. *Acta Montanistica Slovaca* 1(12): 17-23
- [2] Bauer V. et al. (2007) Research of the multibarrier system for an underground deposition of radioactive wastes. *Acta Montanistica Slovaca* 1(12): 217-225
- [3] Adamcová R. et al. (2009) Engineering geological clay research for a radioactive waste repository in Slovakia. *Acta geologica slovacica* 1,2: 71-82
- [4] Galamboš M. et al. (2011) Utilization of Slovak bentonites in deposition of high-level radioactive waste and spent nuclear fuel. *J. Radioanal. Nucl. Chem.* 288(3): 765-777
- [5] Adamcová R. et al. (1996) Heavy metal retardation in some Slovak clays and clayey soils. *Geologica Carpathica Clays* 5(1): 13-20
- [6] Nemes Z et al. (2006) The effect of mineral composition on the interaction of strontium ions with geological formations. *Appl Clay Sci* 32(3-4): 172-178
- [7] Stríček I. et al. (2009) Mineral stability of Fe-rich bentonite in the Mock-Up-CZ experiment. *Geologica Carpathica* 60(5): 431-436
- [8] Osacký M. et al. (2009) Experimental interactions of Slovak bentonites with metallic iron. *Geologica Carpathica* 60(6): 535-543
- [9] Zhang M. et al. (2012) Salt content impact on the unsaturated property of bentonite–sand buffer backfilling materials. *Nuclear Eng. Design.* 250: 35-41
- [10] Misaelides P. et al. (1999) Interaction of actinides with natural microporous materials: A review. *Czech. J. Phys.* 49(1): 167-174
- [11] Adamcová R. (2002) Retardation capability of mineral linings of waste disposal sites. *Acta Geologica Universitatis Comenianae* 57: 5-33
- [12] Valderrama C. et al. (2011) Transport of Strontium Through a Ca-bentonite (Almería, Spain) and Comparison with MX-80 Na-bentonite: Experimental and Modelling. *Water Air Soil Pollut.* 214(1-4): 1-8
- [13] Galamboš M. et al. (2012) Sorption of anthropogenic radionuclides on natural and synthetic inorganic sorbents. *J. Radioanal. Nucl. Chem.* 293(2): 613-633
- [14] Adamcová R. et al. (2005) Vybrané fyzikálne vlastnosti bentonitu pre úložisko rádioaktívneho odpadu. *Mineralia Slovaca* 37(3): 387-389
- [15] Mockovčiaková A. et al. (2010) Enhancement of the bentonite properties. *J. Hazard. Mater.* 180: 274 - 281
- [16] Andrejkovičová S. et al. (2006) Mineralogy and chemistry of Fe-rich bentonite from the Lieskovec deposit (Central Slovakia). *Geologica Carpathica* 57(5): 371-378
- [17] Prikryl R. et al. (2003) Microstructures and physical properties of „backfill“ clays: comparison of residual and sedimentary montmorillonite clays. *Appl Clay Sci* 23(1-4): 149-156
- [18] Galamboš M. et al. (2009) Sorption of strontium on Slovak bentonites. *J. Radioanal. Nucl. Chem.* 281(3): 347-357
- [19] Galamboš M. et al. (2009) Adsorption of cesium on domestic bentonites. *J. Radioanal. Nucl. Chem.* 281(3): 485-492
- [20] Galamboš M. et al. (2010) Adsorption of cesium and strontium on natrified bentonites. *J. Radioanal. Nucl. Chem.* 283(3): 803-813
- [21] Galamboš M. et al. (2010) Cesium sorption on Bentonites and Montmorillonite K10. *J. Radioanal. Nucl. Chem.* 284(1): 55-64
- [22] Galamboš M. et al. (2012) Effect of gamma-irradiation on adsorption properties of Slovak bentonites. *J. Radioanal. Nucl. Chem.* 292(2): 481-492

BRADWELL FED TREATMENT PROJECT

J.HALL (AMIMechE), A.FOWLER (AMIMechE)
Nuclear Decommissioning, Atkins
Bennett House, Pleasley Road, Rotherham, S60 4HQ - United Kingdom
Chadwick House, Birchwood Park, Warrington, WA3 6AE - United Kingdom

ABSTRACT

This project is a partnership between Costain and Atkins for Magnox Ltd, to reduce the volume of Intermediate Level Waste (ILW) that is bound for long term storage, ultimately in the Geological Disposal Facility (GDF).

One of the Intermediate Level Waste (ILW) streams generated at Bradwell (BWA) nuclear power station is in the form of Fuel Element Debris (FED). FED is redundant magnesium and aluminium metal alloy that was used for the longitudinal splitter vanes and cross braces that located a fuel element centrally in a reactor channel, aided element stability and provided additional surface area to the fuel element for heat exchange efficiency. Following reactor refuelling the spent fuel elements were transferred to the site cooling ponds. Whilst in the cooling ponds the fuel elements were “de-splittered” to remove the longitudinal splitter vanes and cross braces to improve the packing efficiency of the fuel in the transport flasks during transfer for reprocessing. The FED was placed in temporary (awaiting decommissioning) storage within below ground concrete vaults in the Active Waste Compound (AWC).

As a part of site decommissioning the FED waste must be retrieved, processed and placed in a passive state. The site is looking to reduce this volume, estimated at 556m³ including FED sludge, and nimonic springs by dissolving the FED waste in a dilute nitric acid solution. Dissolution in nitric acid should provide a 20 fold reduction in waste volume. This is a ‘first of a kind’ process and following the award of the contract to Costain, Magnox’s reference design was developed by a joint team from Costain and Atkins to a HAZOP II level and is currently being implemented by the same team.

The mechanical aspects of the design were not easily isolated due to the multi-disciplinary nature of the project. Following the HAZOP study a value engineering exercise resulted in fundamental design changes. We will discuss the impact of these changes on the design and the challenges faced trying to maintain an already accelerated programme. As an integrated team, the project team have had to overcome, not only technical challenges, but the challenges of integrating systems of work between multiple organisations.

1. Introduction

1.1 What is FED?

Fuel Element Debris (FED) is generated during the “de-splittering” process in which the magnesium alloy longitudinal splitter vanes and cross braces are removed from the fuel element (See Figure 1) to improve the packing efficiency of the fuel in the transport flasks during transfer for reprocessing.

During operation of the reactor the longitudinal splitter vanes and cross braces located a fuel element centrally in a reactor channel, aided element stability and provided additional surface area to the fuel element for heat exchange efficiency. The end cap assembly (See Figure 1) incorporates a catch mechanism that provides positive engagement of the fuel element during operation. Within this mechanism there is a nimonic spring which is made of high cobalt steel to enable correct functioning in the high temperature environment of the reactor. Due to the cobalt content of the spring it becomes an activated component.



Figure 1 – Magnox Fuel Element

Once the FED had been decoupled from the fuel element it was deposited into a series of underground vaults for storage (See Figure 2). The “de-splitting” process results in some of the nimonic springs becoming mixed in with the FED. It is estimated that there are 1000 springs within the 556m³ of waste in the FED vaults at Bradwell.



Figure 2 – Typical FED Vault aperture at Bradwell

1.2 Why Dissolution?

Traditionally, ILW waste streams, such as FED, were planned to be transferred to Radioactive Waste Management Directorate (RWMD) compliant 3m³ boxes and encapsulated in a cementitious grout. The filled boxes were then to be ultimately placed into long term storage. This method results in an increased waste volume and significant cost associated with long term storage of nuclear waste.

An alternative process, Dissolution, has been devised by Magnox which involves dissolving the FED waste in dilute nitric acid. Since the majority of the waste is dissolvable, the amount of solid waste destined for long term storage is significantly reduced (See Figure 3). This presents a considerable cost saving.

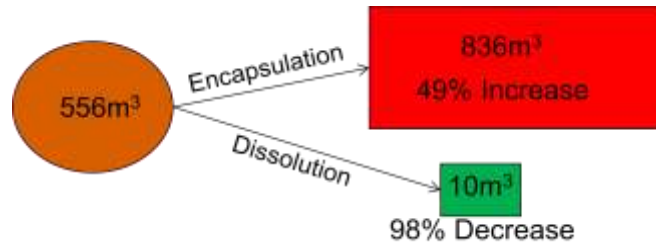

Figure 3 – FED Waste stream comparison

1.3 Project Scope

The original project scope tendered by Magnox Ltd was to develop a reference design and safety assessment capable of retrieving waste from the vaults, sorting out identifiable undissolvable items from the waste and processing the dissolvable FED waste. The plant also had to treat the resulting liquor to meet site discharge requirements. This project was awarded to Costain with Atkins as their strategic Partner

Part way through the design development phase of the project the scope was redefined as a result of a value engineering exercise. The revised scope of work (as it currently stands – October 2012) is to deliver a ‘first of a kind’ nitric acid dissolution facility capable of accepting the retrieved FED, in 200L drums, processing of the FED waste (including sorting and dissolving) and discharge of the resulting liquor to an onsite active effluent treatment plant. Non dissolvable waste will remain the responsibility of Magnox to obtain a safety case and design for onward packaging, processing and storage.

2. Facility Design and Process

An existing building on site, approximately 17m X 12m was allocated to accommodate all the equipment required to carry out the dissolution process. This included; mechanical handling equipment, reaction vessels and associated process pipework and HVAC plant. The layout of the key equipment can be seen in Figure 4 and Figure 5

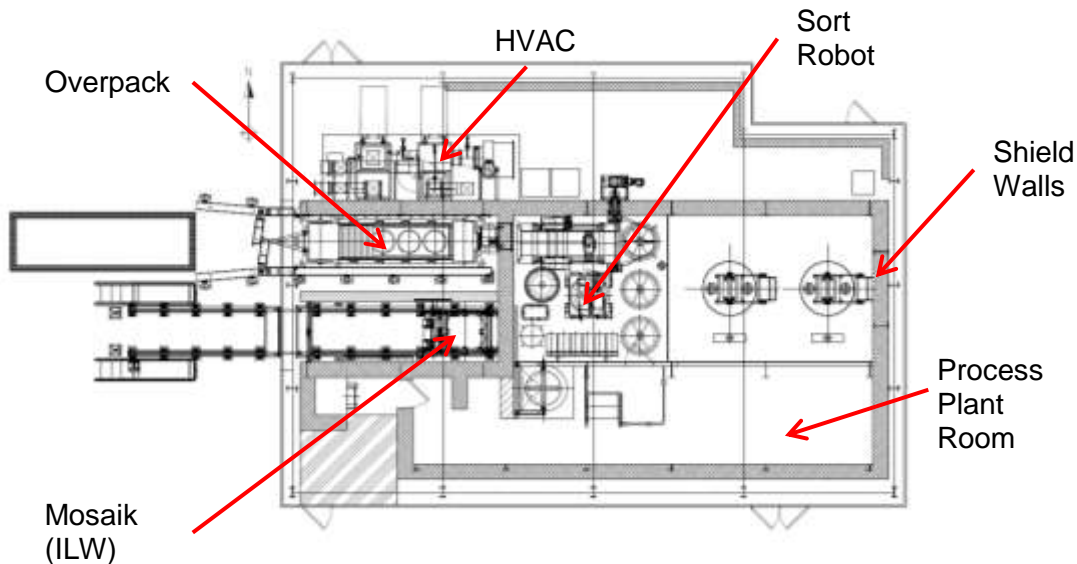

Figure 4 – Plan View of Dissolution Facility

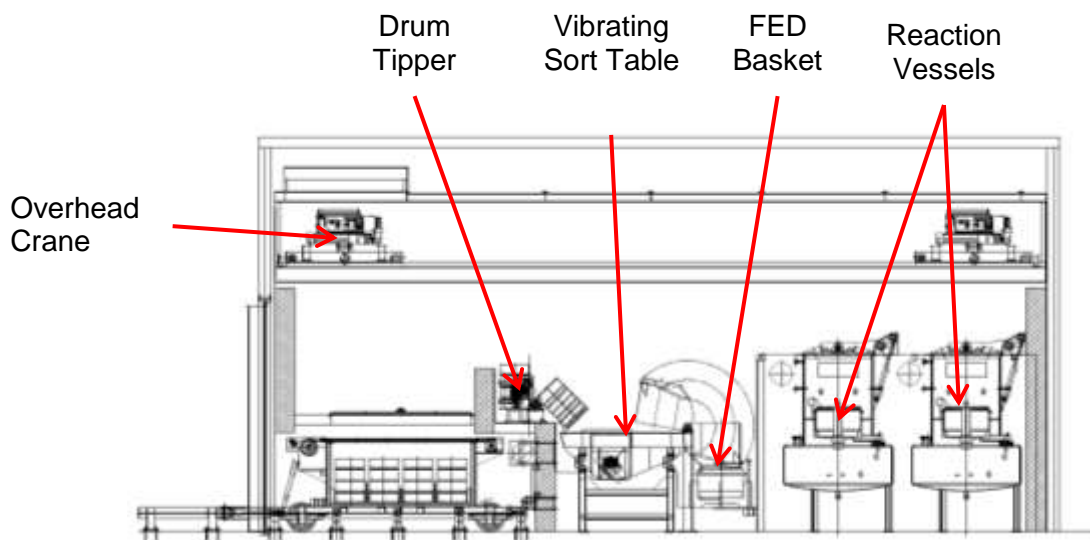

Figure 5 - Sectional View of Dissolution Facility

The dissolution process begins with the import of a transport overpack containing four 200L drums containing FED which has been retrieved from the underground vaults. The Overhead crane then retrieves a drum at a time from the import bay. The crane is fitted with a pintle grab arrangement which has been designed to pick up a common pintle, lifting feature that has been incorporated into plant items within the facility. The drums are lifted using a proprietary drum grab that has been modified to accept the aforementioned pintle.

Once the drum has been retrieved it is then lowered into a drum tipper, which will tip the drum in order to deposit the contents on to the vibrating table. At this point the sort robot will be used to level the waste if needed and scan for high dose rate items. Should any activated items be identified then the sort robot will remove and place on to an ILW tray which will later be exported as ILW. Any identifiable non-ILW is also removed and placed into a designated non-ILW 200l drum. This waste is then passed out of the facility for downstream characterisation.

The vibrating table transfers the FED into the FED basket. Using the overhead crane, the Basket is lifted and transferred to the reaction vessel where the FED is dissolved in Nitric Acid. The reaction process is a novel application of nitric acid dissolution and, based upon Research & Development results to-date the batch dissolution is expected to take approximately 2hrs. Once the reaction is complete the basket is removed and any undissolved items are removed from the basket using the sort robot and placed in an ILW tray.

The 200l drum is then returned to the import bay and the process is repeated for the remaining drums. The ILW Trays, once full are placed, using the overhead crane and pintle grab, into the designated shielded ILW export drum, a MOSAIK.

3. Current Status of Project

At the time of writing this paper the majority of the engineering design for the Bradwell Dissolution project has been completed. The waste handling process has been through a HAZOP (Hazard and Operability) level 2 study and the actions resulting from this study are all but closed out. In addition the Design Justification Reports for each of the engineering disciplines have been reviewed by the client and the majority are close to being issued.

Orders have been placed for most items of equipment some of which were design and build contracts while others have been build to print contracts. The first few of these contracts are nearing completion and are close to completing their factory acceptance testing (FAT) before shipment to site.

One major piece of equipment in this facility is the sort robot. This has a number of functions which aid in the transfer of FED waste from the incoming drums and into the reaction vessels and also in sorting and segregation of non-compliant (not suitable for dissolution) waste into ILW and non-ILW waste streams. The robot, its tools, and the control system have recently successfully completed its FAT at the vendor works where a mock up of the cell was created (See Figure 6). This is a major milestone for the project and for the company that has supplied the robot and programmed the control system. The next stage for this equipment is to get the operators familiar with how it operates and to give them experience of using it within the cell mock up which was created for the FAT. By doing this the operators can gain experience on the equipment they will actually be using in the final facility before the plant starts handling active waste.



Figure 6 – Sort Robot FAT Cell Mock up

Site works are well advanced and, in a significant deviation from usual Magnox practice, Costain has taken responsibility for the management controls of its own works within the RCA. Benchmark SHE performances are being achieved and performance efficiency is significantly improved on the usual norms for RCA working.

The majority of the civil and structural work is complete. This includes casting of new concrete plinths around the facility location to support pipe racks, acid tanks, air handling units, control rooms, electrical switchgear rooms and much more besides. In addition work inside the existing site building has been progressing. The main portal frame steel structure which supports the electric overhead travelling crane (EOTC) has been erected and the 400mm thick concrete shield walls have also been put in place between the columns of the portal frames. Following substantial completion of civil/structural works, ME&I installation is progressing well. Moving forward the manufacture of the remaining items of equipment is to be completed and the FAT completed. The items are then to be shipped to site and installed into the facility before any remaining structural and civil work is completed. This is to include the in cell cladding which forms a containment boundary which is also easily decontaminable. Equipment will then be site tested and commissioned before inactive and active commissioning of the facility takes places towards the middle part of next year (2013).



European Nuclear Society
Rue Belliard 65
1040 Brussels, Belgium
Telephone: +32 2 505 30 50 - FAX: +32 2 502 39 02
enc2012@euronuclear.org
www.enc-2012.org